



인천시 우수
공공디자인인증

아 름 다 운 길

BEAUTIFUL

R O A D

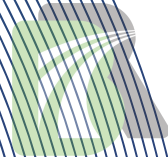

(주) 아름다운길

BEAUTIFUL ROAD CO., LTD.

PUBLIC INSTALLATION PROVIDER

교통안전시설물

버스승강장 및 횡스

볼라드 및 자전거 보관대

금속구조물창호공사

도장공사



(주) 아름다운길

BEAUTIFUL ROAD CO., LTD.



(주) 아름다운길

BEAUTIFUL ROAD CO., LTD.

“사람과 자연이 함께하는 ‘아름다운길’을 만드는 곳”

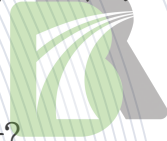

(주) 아름다운길

BEAUTIFUL ROAD CO., LTD.

안녕하십니까?

주식회사 아름다운길은 창립 이래 금속구조물창호온실공사 및 도장공사, 조달청 다수공급자계약(MAS)납품을 주 사업으로 하는 법인으로 사랑 받아온 기업입니다.

최상의 품질, 독자적 기술개발, 납기준수라는 방침을 경영활동의 기본으로 삼아 이를 위한 꾸준한 개발과 고품질의 제품생산 및 환경친화적인 제품, 창의적 디자인 연구를 통해서 고객 만족을 최우선으로 하는 기업이 되도록 노력할 것을 약속드립니다.

항상 원칙과 기본에 충실하고 고객에게 신뢰받는 기업이 되도록 노력할 것이며 앞으로도 변함없는 관심과 성원, 아낌없는 충고를 보내주시고 저희의 도약과 발전을 지켜봐 주시기 바랍니다.

감사합니다.



대표 임 태 희
(주) 아름다운길

BEAUTIFUL ROAD CO., LTD.

회사 개요 |

상 호	주식회사 아름다운길
대 표	 임태희 (주) 아름다운길 BEAUTIFUL ROAD CO., LTD.
본 사	인천광역시 서구 신동길 39, 1동(금곡동)
공 장	인천광역시 서구 신동길 39, 1동(금곡동)
개업연월일	2015년 1월 14일
전화번호	032) 710-3288
팩스번호	032) 710-3289
E-mail	broad111@naver.com
제작품목 및 시공	<ul style="list-style-type: none"> ■ 교통안전시설물 ■ 버스승강장 및 휠스 ■ 볼라드 및 자전거 보관대 ■ 금속구조물창호공사 ■ 도장공사  (주) 아름다운길 BEAUTIFUL ROAD CO., LTD.

회사 연혁



조직도



공정표



인 증 서

2022 인천굿디자인(BR-F-59, BR-F-62)



INCHEON GOOD DESIGN

2022 인천굿디자인 인증서
CERTIFICATE OF INCHEON GOOD DESIGN 2022



기 업 명	(주)아름다운길
대 표	김 라 호
제 품 명	보행자 란스
모 델 명	BR-F-59
인 증 번 호	IGD-22-0001
인 증 기 간	2023. 3. 1. ~ 2026. 3. 31. (3년)

위 디자인은 인천광역시 공공디자인 진흥 조례 제20조에 의거하여 인천굿디자인으로 선정되었음을 증명합니다.

2023. 3. 21.

인천광역시 

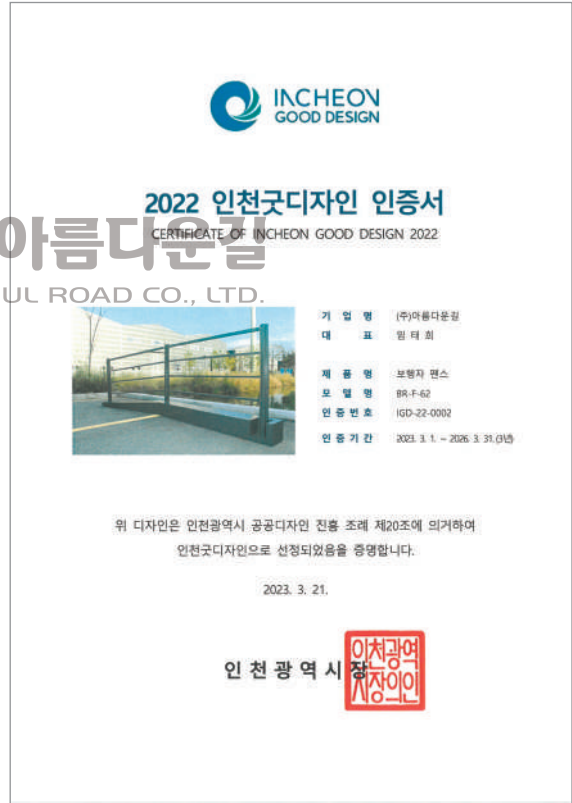

INCHEON GOOD DESIGN

2022 인천굿디자인 인증서
CERTIFICATE OF INCHEON GOOD DESIGN 2022



기 업 명	(주)아름다운길
대 표	김 라 호
제 품 명	보행자 란스
모 델 명	BR-F-62
인 증 번 호	IGD-22-0002
인 증 기 간	2023. 3. 1. ~ 2026. 3. 31. (3년)

위 디자인은 인천광역시 공공디자인 진흥 조례 제20조에 의거하여 인천굿디자인으로 선정되었음을 증명합니다.

2023. 3. 21.

인천광역시 



알루미늄제교량난간



(주) 아름다운길
BEAUTIFUL ROAD CO., LTD.

ALUMINUM BRIDGE FENCE



(주) 아름다운길
BEAUTIFUL ROAD CO., LTD.



(주) 아름다운길
BEAUTIFUL ROAD CO., LTD.

알루미늄제교량난간

※현장설치도

Model Name	Materials	Size	G2B Number	Price
BR-ABF-1	AL	W2.0 × H1.1	24771640	₩280,000/m당(VAT포함)



(주) 아름다운길
BEAUTIFUL ROAD CO., LTD.



Dimension

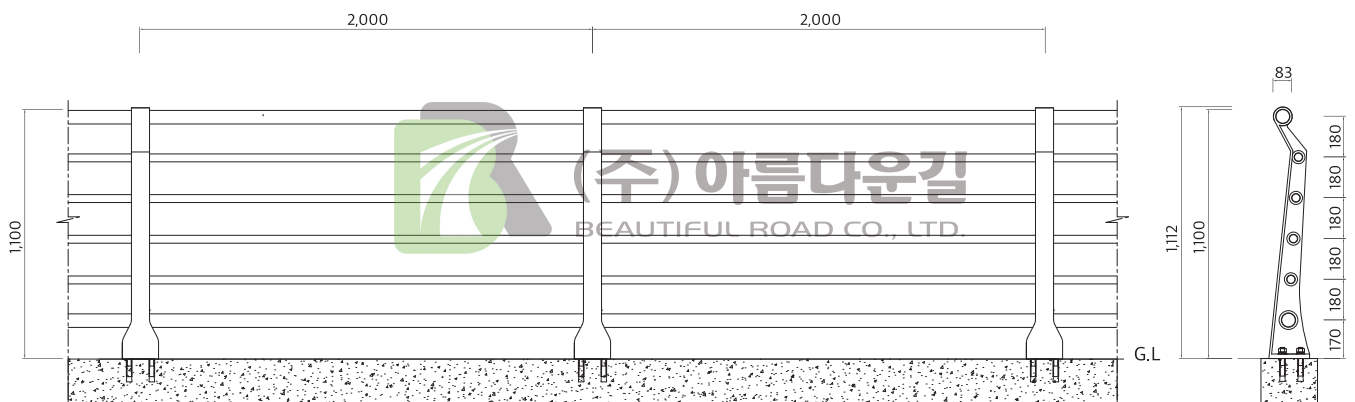

※현장설치도

Model Name	Materials	Size	G2B Number	Price
BR-ABF-2	AL	W2.0 × H1.2	24771641	₩300,000/m당(VAT포함)



Dimension

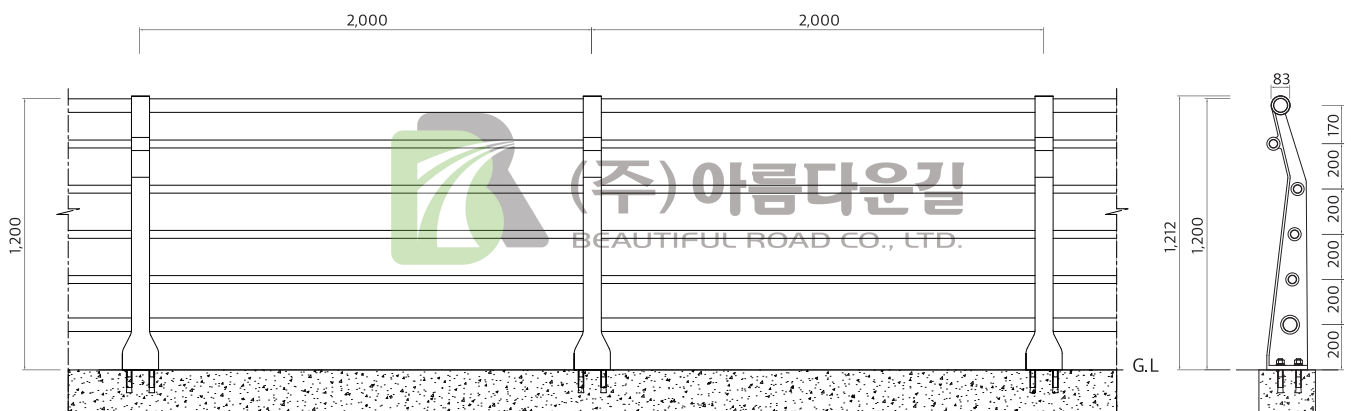

알루미늄제교량난간

※현장설치도

Model Name	Materials	Size	G2B Number	Price
BR-ABF-3	AL	W2.0 × H1.2	24771642	₩270,000/m당(VAT포함)



Dimension

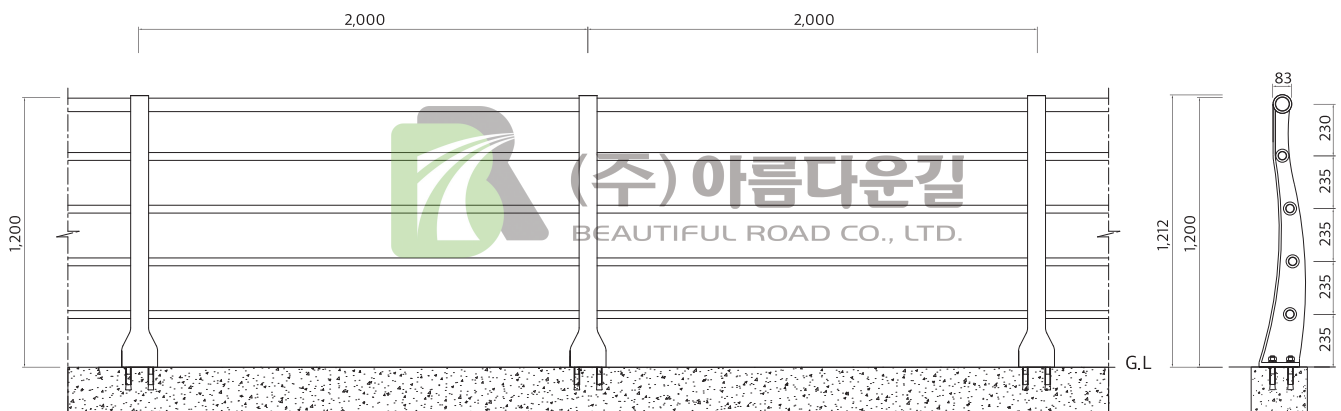

디자인형울타리



(주) 아름다운길
BEAUTIFUL ROAD CO., LTD.

DESIGN FENCE



(주) 아름다운길
BEAUTIFUL ROAD CO., LTD.



(주) 아름다운길
BEAUTIFUL ROAD CO., LTD.

디자인형울타리

※현장설치도

Model Name	Materials	Size	G2B Number	Price
BR-F-62	STEEL	W2.0 × H1.1	24662990	₩340,000/경간(VAT포함)

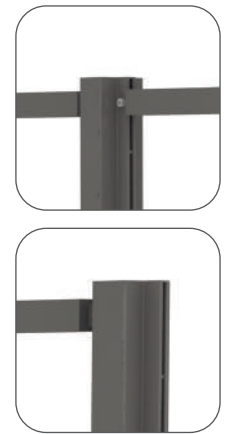

Dimension

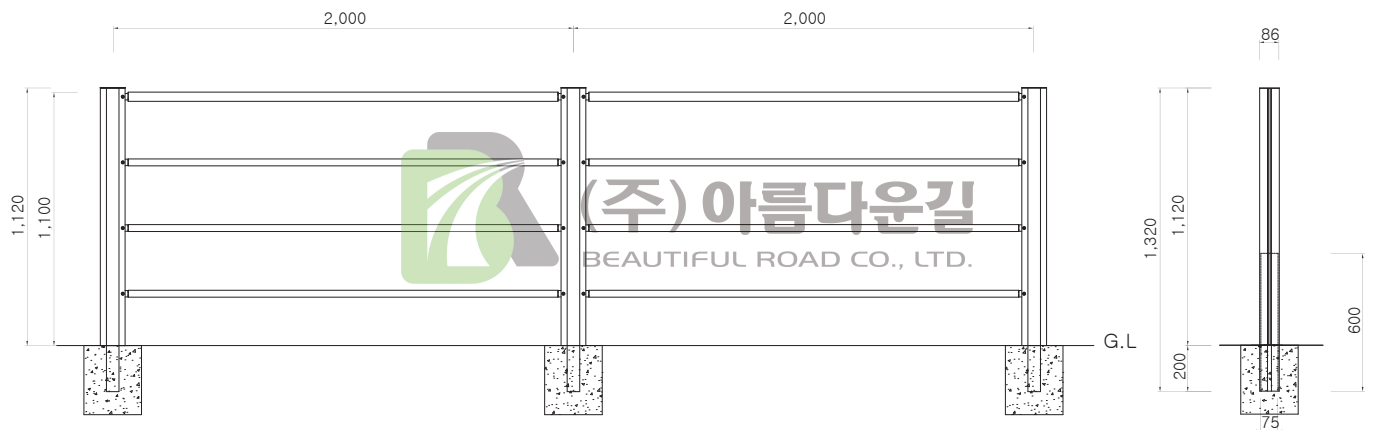

※현장설치도

Model Name	Materials	Size	G2B Number	Price
BR-F-59	STEEL	W1.8 × H1.1	24880818	₩360,000/경간(VAT포함)



Dimension

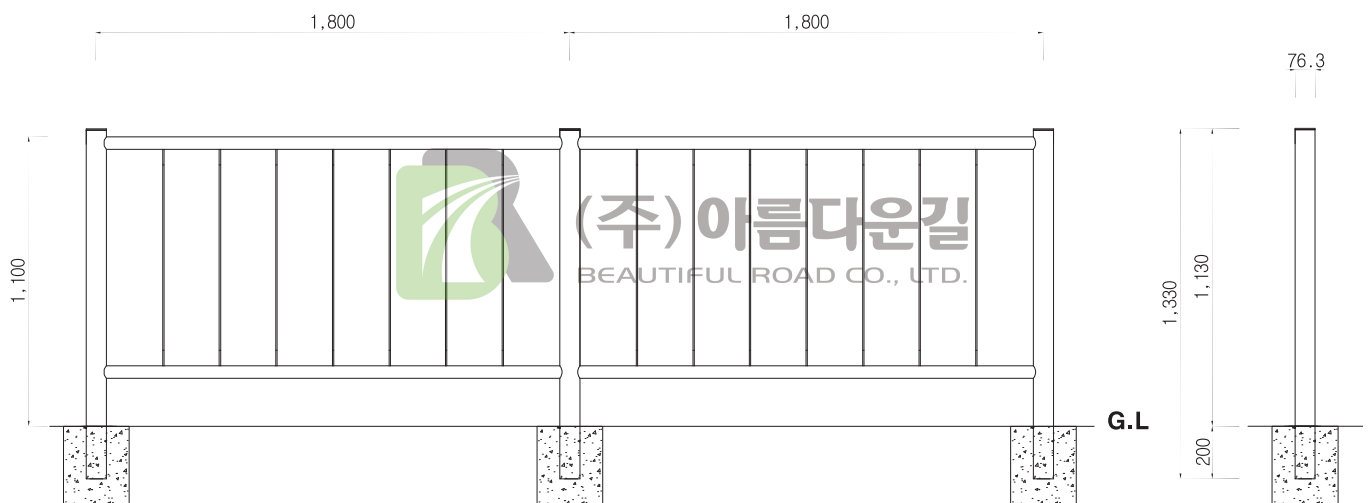

디자인형울타리

※현장설치도

Model Name	Materials	Size	G2B Number	Price
BR-F-3	STEEL/AL	W1.8 × H1.1	24318690	₩361,000원/경간(VAT포함)



STEEL •
분체도장(수요처지정색)

AL •



Dimension

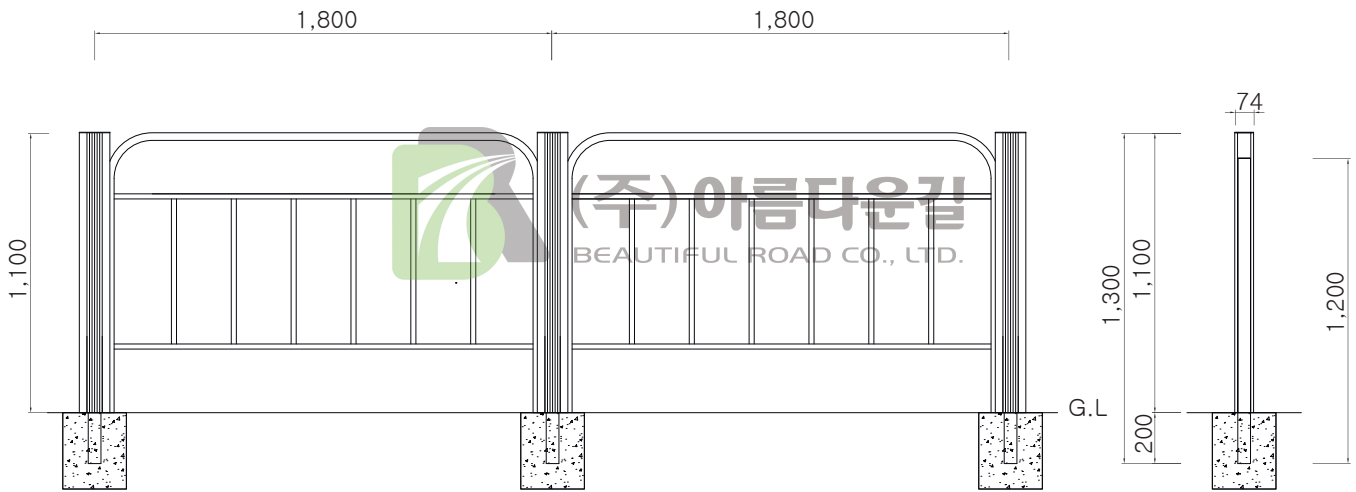

Example of Construction



디자인형울타리

※현장설치도

Model Name	Materials	Size	G2B Number	Price
BR-F-5	STEEL/AL	W1.8 × H1.1	24318691	₩315,000원/경간(VAT포함)



STEEL •.....
분체도장(수요처지정색)

AL •.....



Dimension

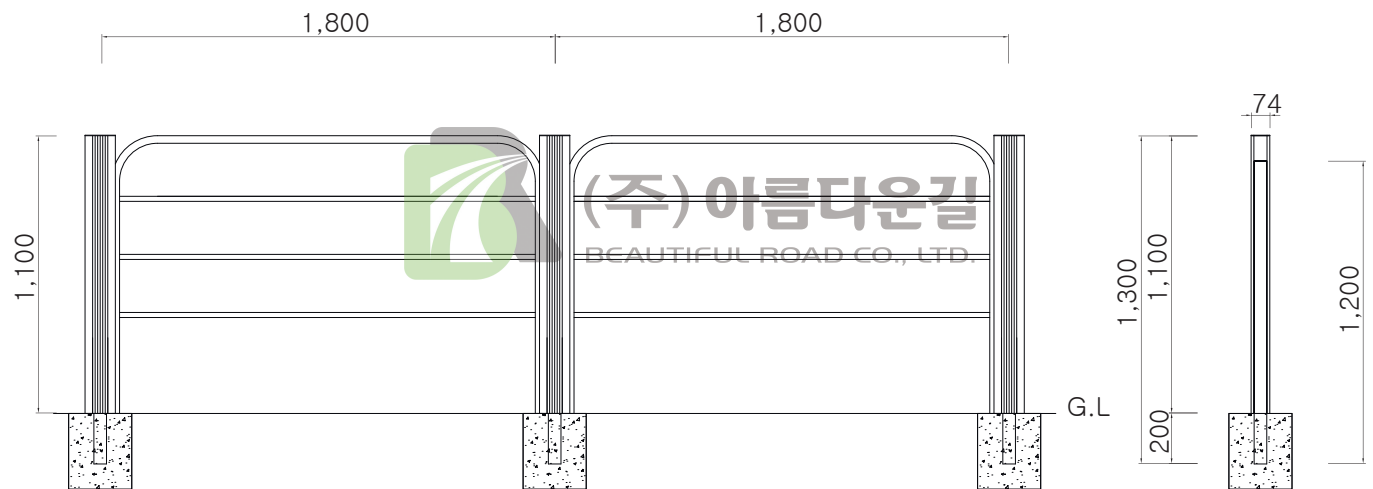

Example of Construction



디자인형울타리

※현장설치도

Model Name	Materials	Size	G2B Number	Price
BR-F-17	STEEL	W2.0 × H1.1	24324643	₩355,000원/경간(VAT포함)

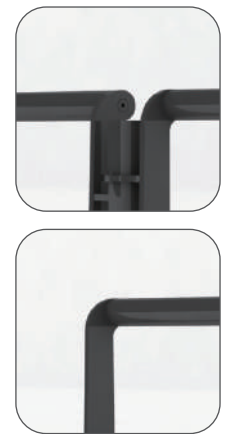

STEEL •.....
분체도장(수요처지정색)



Dimension

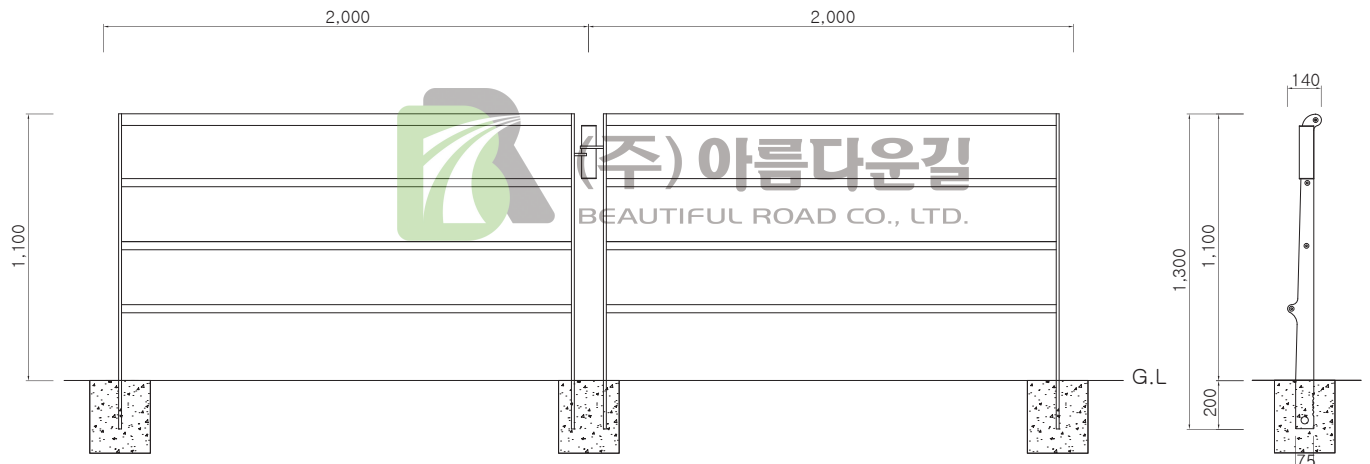

Example of Construction



디자인형울타리

※현장설치도

Model Name	Materials	Size	G2B Number	Price
BR-F-18	STEEL	W2.0 × H1.1	24324644	₩380,000원/경간(VAT포함)

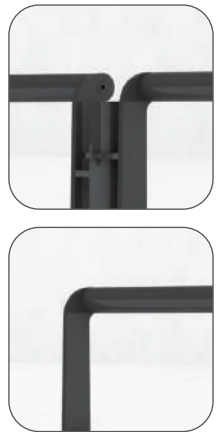

STEEL •.....
분체도장(수요처지정색)



Dimension

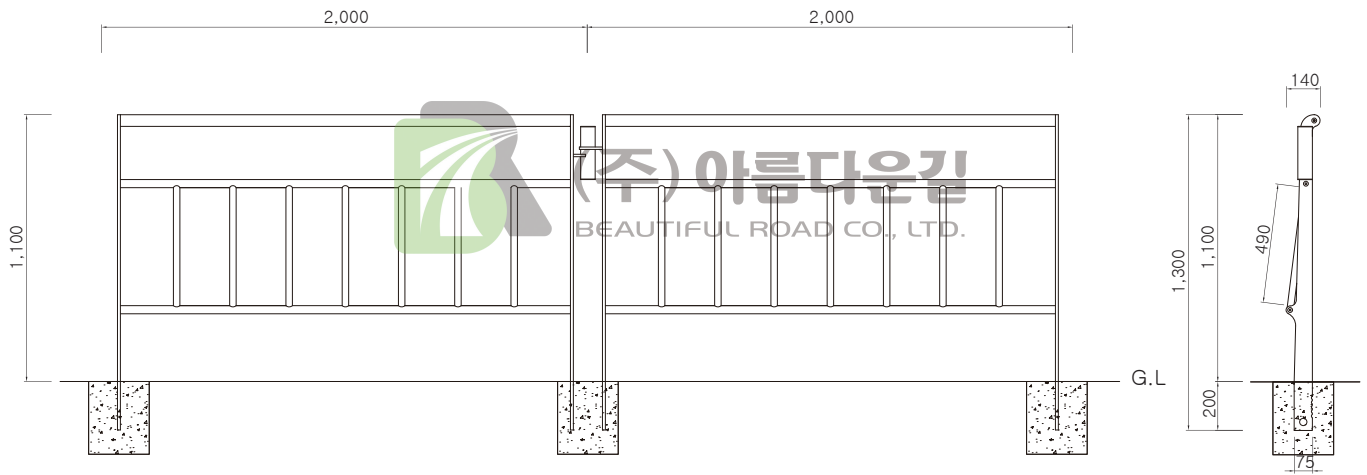

Example of Construction



디자인형울타리

※현장설치도

Model Name	Materials	Size	G2B Number	Price
BR-F-39	STEEL	W1.8 × H1.1	24318692	₩345,000원/경간(VAT포함)

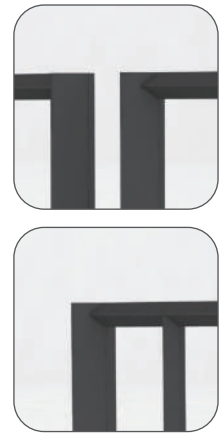

STEEL •
분체도장(수요처지정색)



Dimension

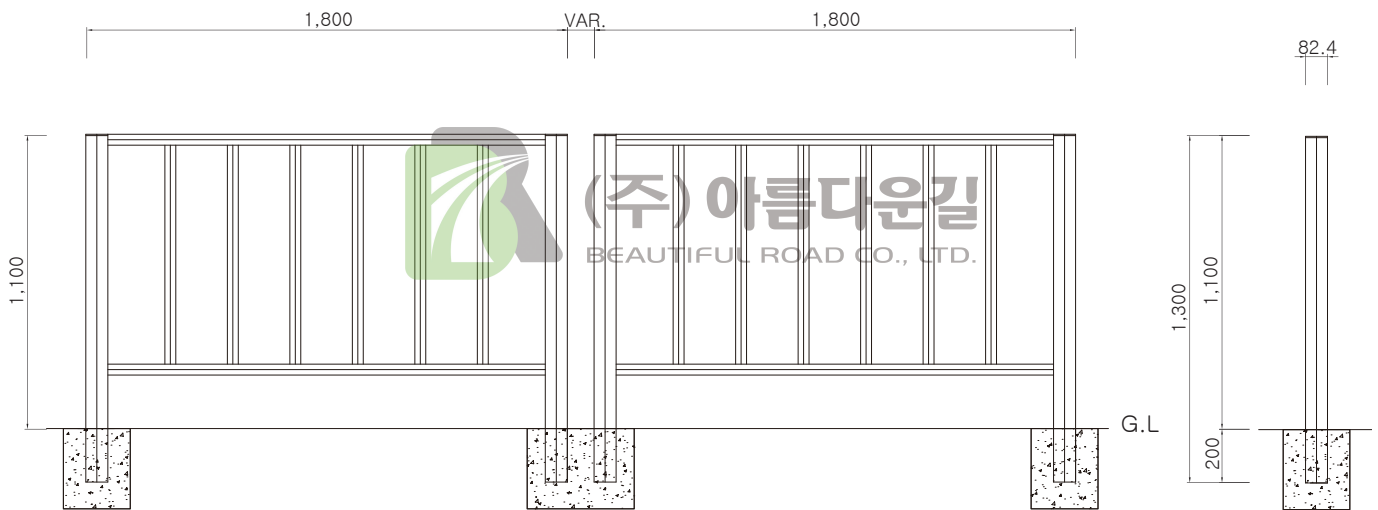

Example of Construction



디자인형울타리

※현장설치도

Model Name	Materials	Size	G2B Number	Price
BR-F-40	STEEL/AL/STS	W1.8 × H1.1	24318693	₩303,000원/경간(VAT포함)



(주)아름다운길
BEAUTIFUL ROAD CO., LTD.



STS •
분체도장(수요처지정색)

AL •
AL



STEEL •
STEEL



(주)아름다운길
BEAUTIFUL ROAD CO., LTD.

Dimension

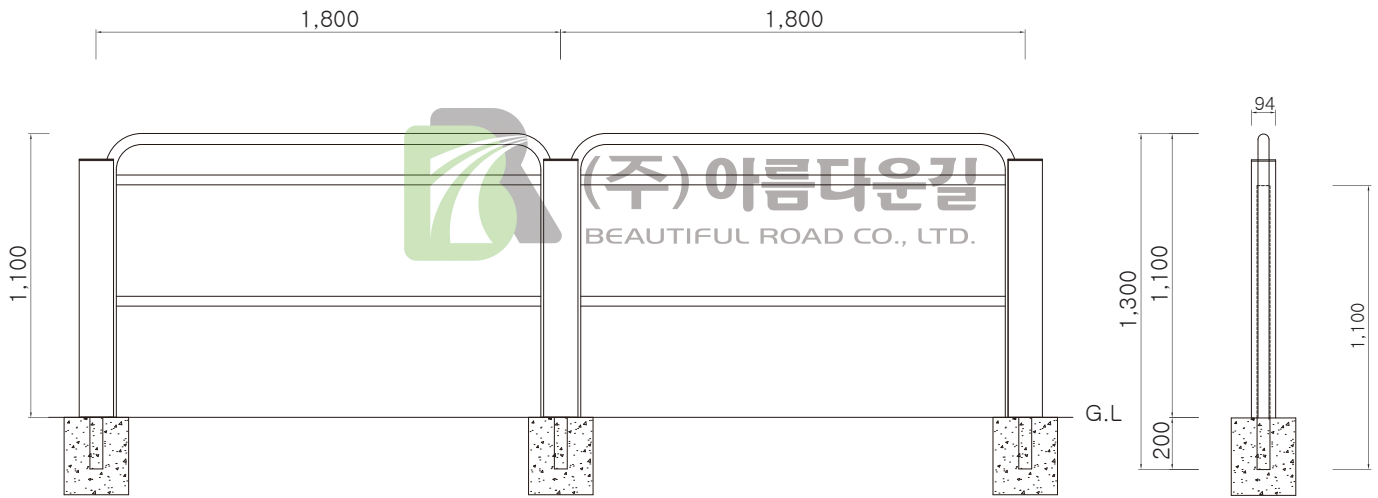

Example of Construction



디자인형울타리

※현장설치도

Model Name	Materials	Size	G2B Number	Price
BR-F-41	STEEL/AL/STS	W2.0 × H1.1	24318694	₩335,000원/경간(VAT포함)

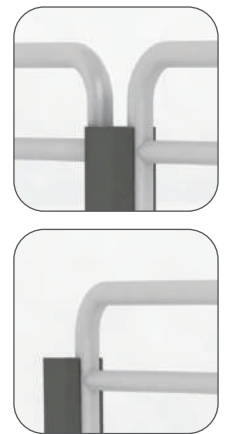

STS •.....
분체도장(수요처지정색)

AL •.....

STEEL •.....

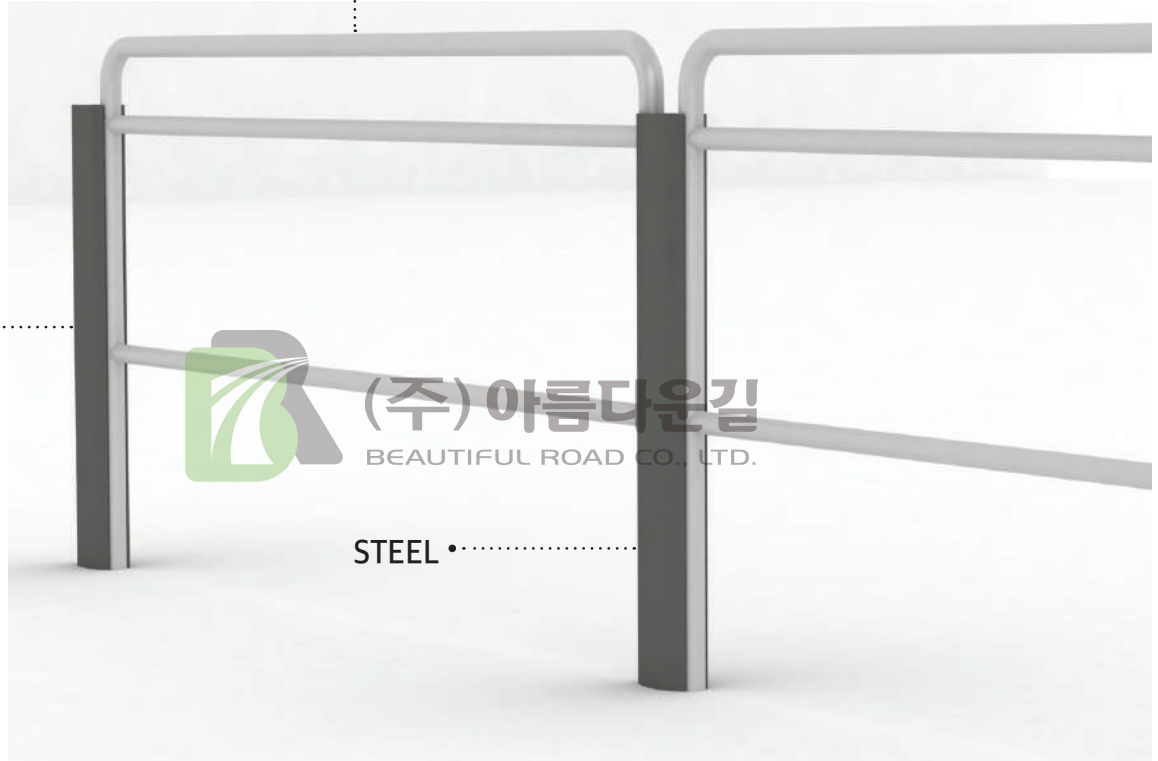

Dimension

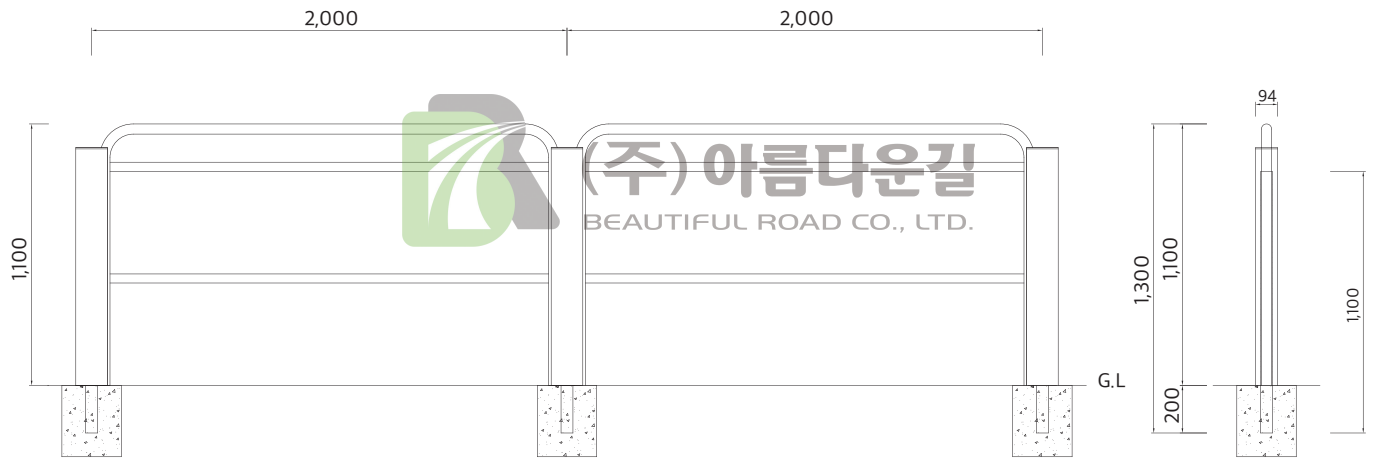

Example of Construction



디자인형울타리

※현장설치도

Model Name	Materials	Size	G2B Number	Price
BR-F-42	STEEL	W1.8 × H1.1	24318695	₩370,000원/경간(VAT포함)



(주) 아름다운길
BEAUTIFUL ROAD CO., LTD.



STEEL •
분체도장(수요처지정색)



(주) 아름다운길
BEAUTIFUL ROAD CO., LTD.

Dimension

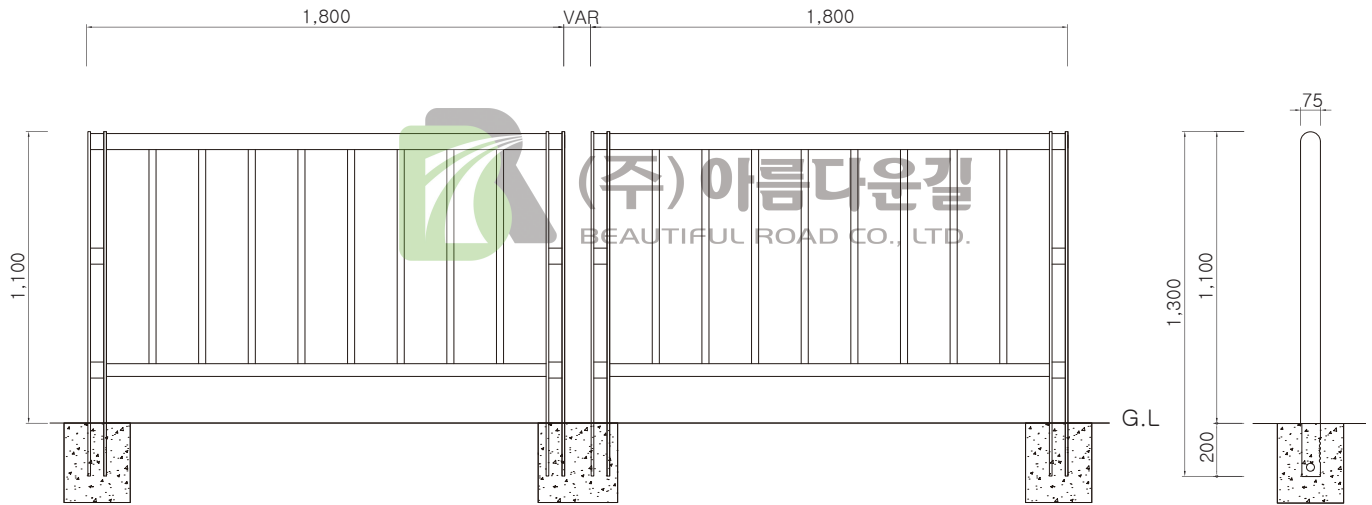

Example of Construction



디자인형울타리

※현장설치도

Model Name	Materials	Size	G2B Number	Price
BR-F-44	STEEL	W1.8 × H1.1	24318696	₩340,000원/경간(VAT포함)

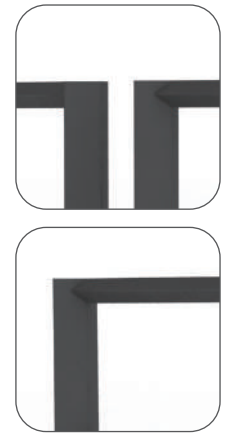

STEEL •
분체도장(수요처지정색)



Dimension

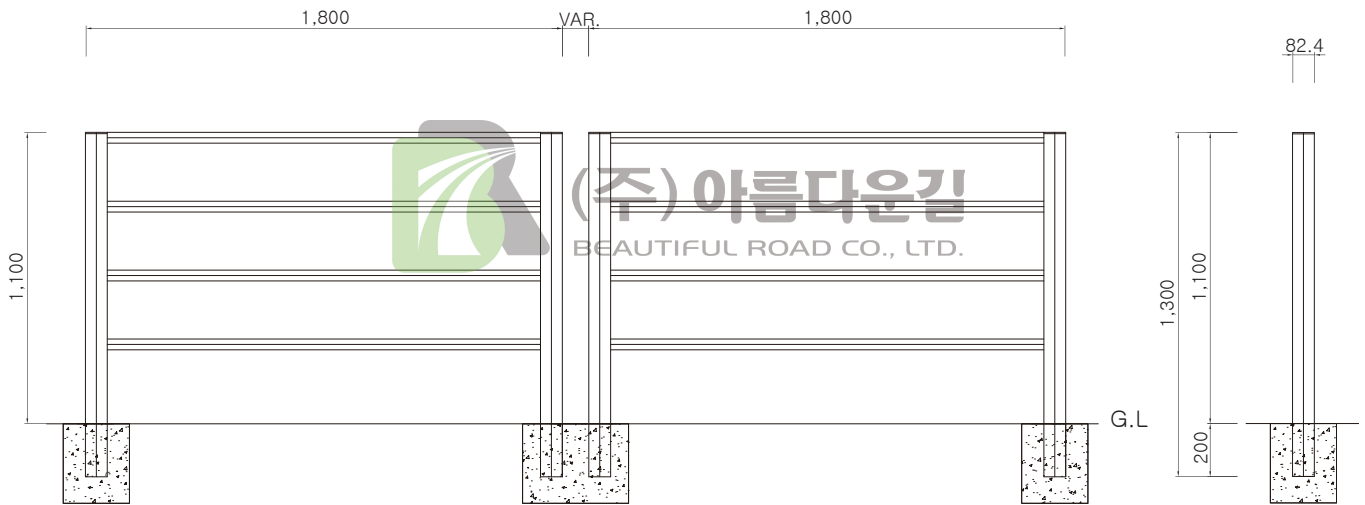

Example of Construction



디자인형울타리

※현장설치도

Model Name	Materials	Size	G2B Number	Price
BR-FA-1	STEEL/AL	W2.0 × H1.2	24318697	₩455,000원/경간(VAT포함)

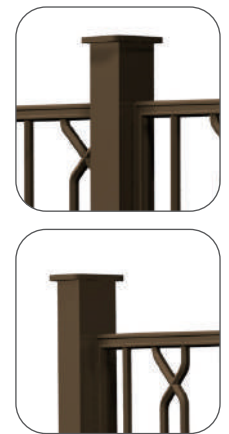

AL •.....
분체도장(수요처지정색)

STEEL •.....



Dimension

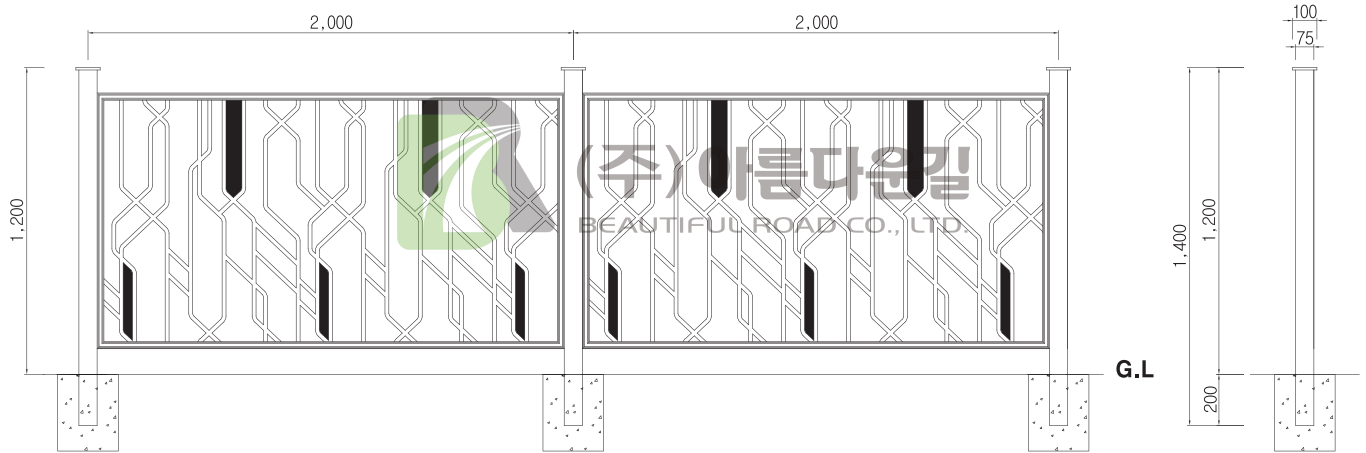

Example of Construction

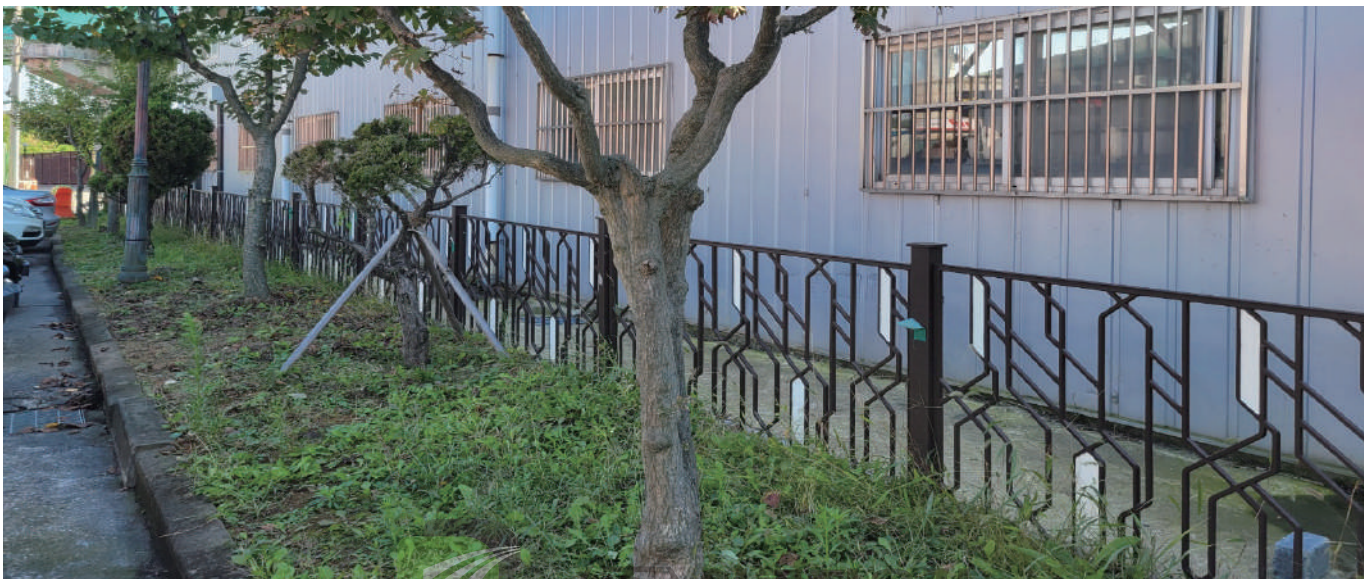

디자인형울타리

※현장설치도

Model Name	Materials	Size	G2B Number	Price
BR-F-26	STEEL	W1.8 × H1.2	24450508	₩285,000/경간(VAT포함)



Dimension

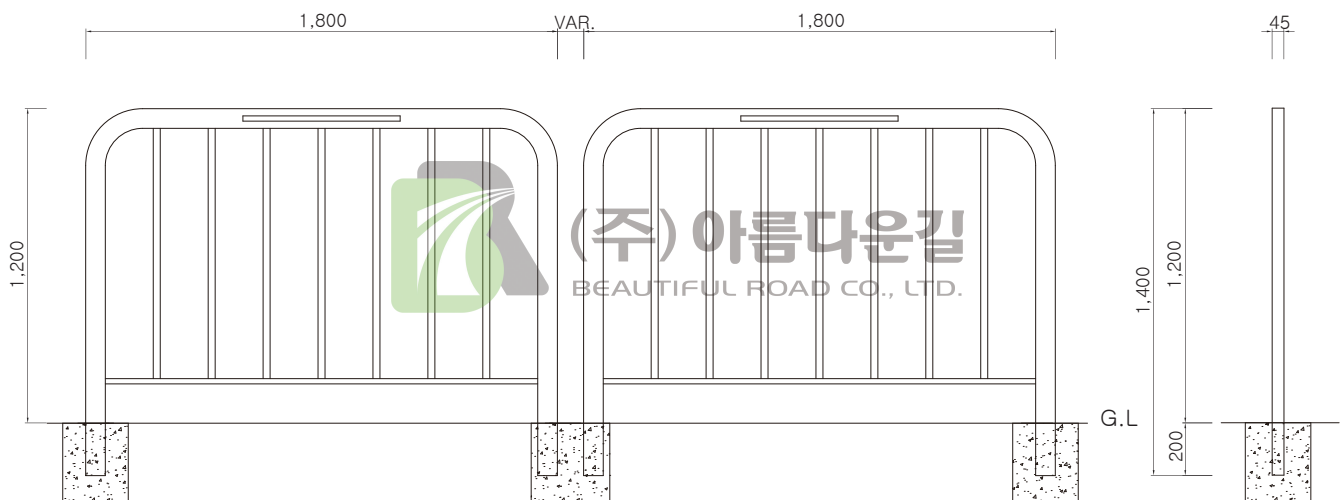

※현장설치도

Model Name	Materials	Size	G2B Number	Price
BR-F-47	STEEL	W1.8 × H1.1	24657081	₩340,000/경간(VAT포함)



Dimension

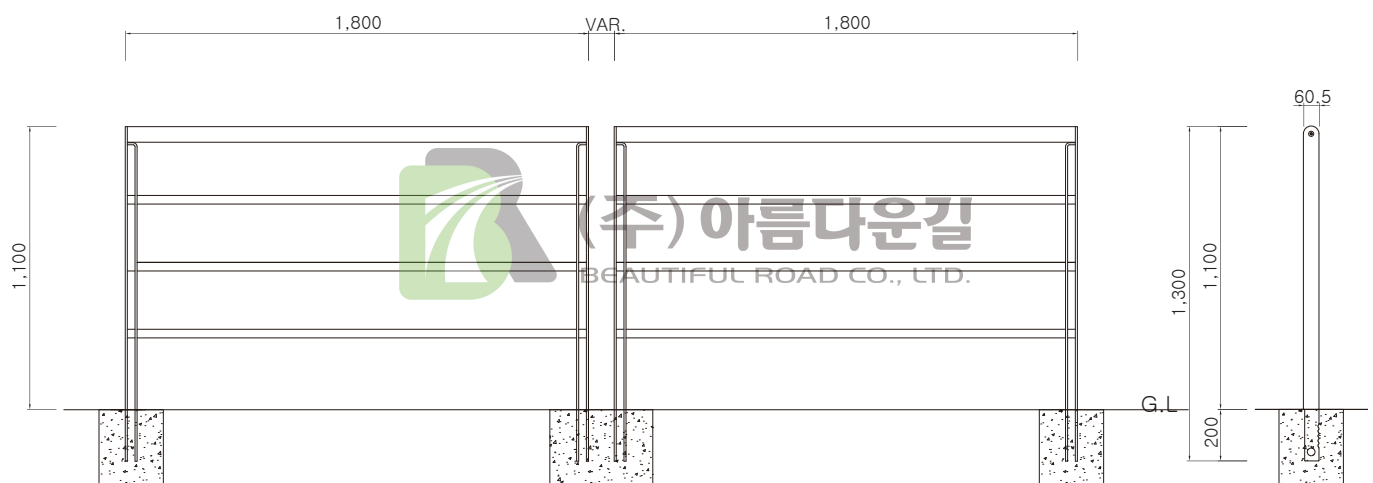

디자인형울타리

※현장설치도

Model Name	Materials	Size	G2B Number	Price
BR-F-48	STEEL	W1.8 × H1.1	24657082	₩360,000/경간(VAT포함)



Dimension

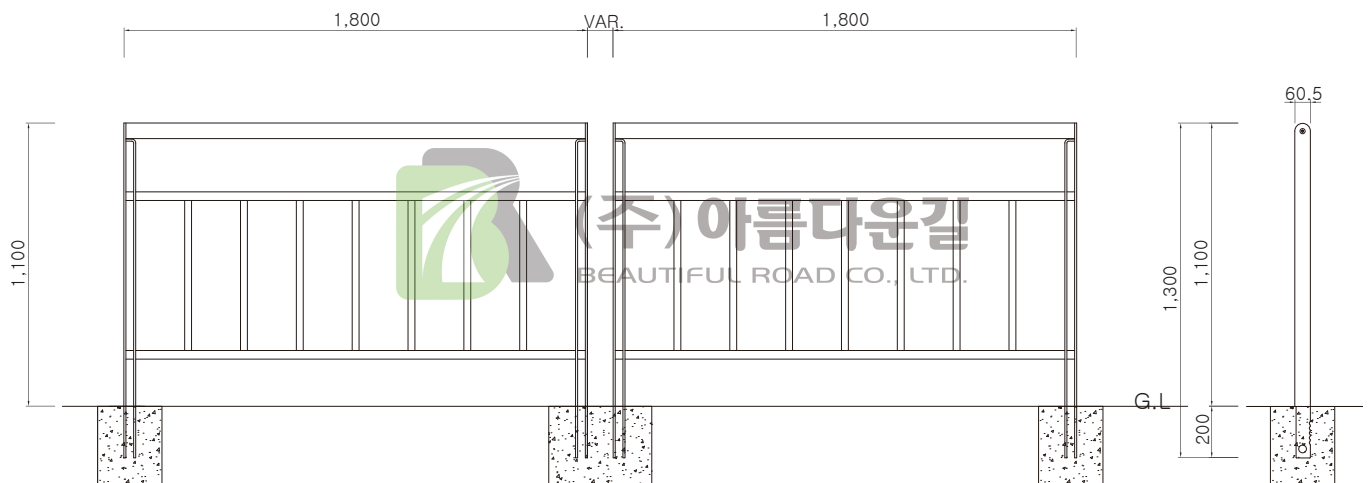

※현장설치도

Model Name	Materials	Size	G2B Number	Price
BR-F-52	STEEL	W1.9 × H1.2	24450509	₩340,000/경간(VAT포함)



Dimension

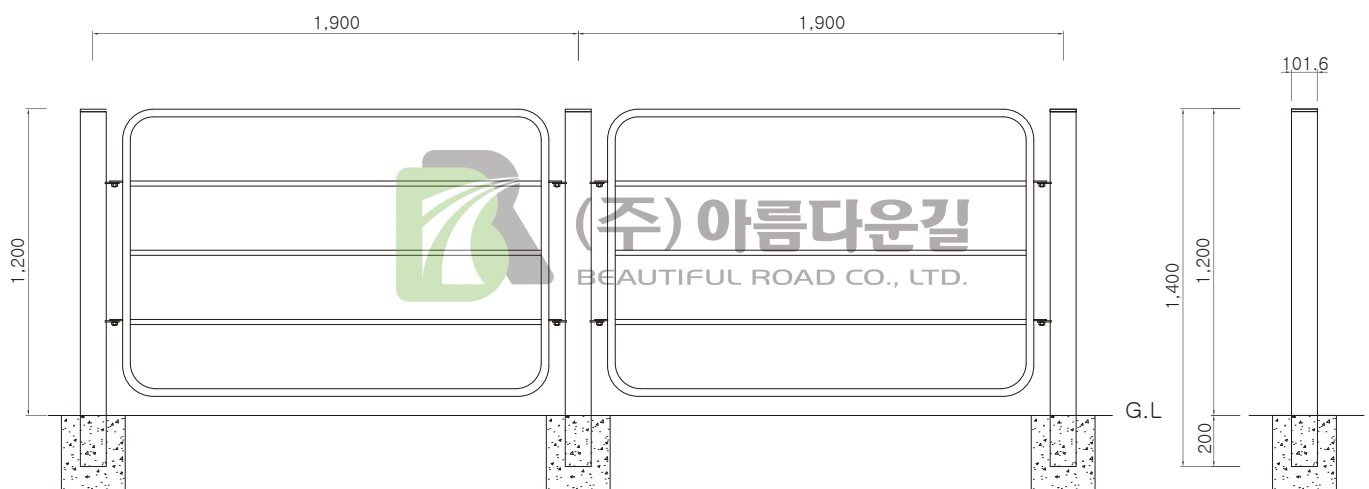

디자인형울타리

※현장설치도

Model Name	Materials	Size	G2B Number	Price
BR-F-53	STEEL	W1.9 × H1.2	24450510	₩350,000/경간(VAT포함)



Dimension

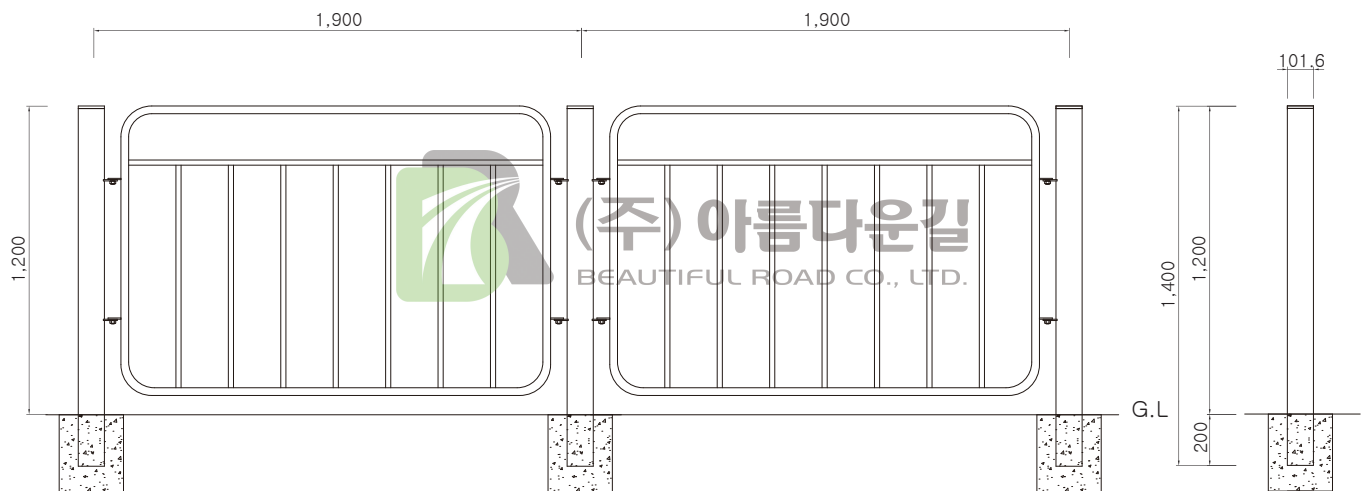

※현장설치도

Model Name	Materials	Size	G2B Number	Price
BR-F-54	STEEL	W1.9 × H1.2	24450511	₩370,000/경간(VAT포함)



Dimension

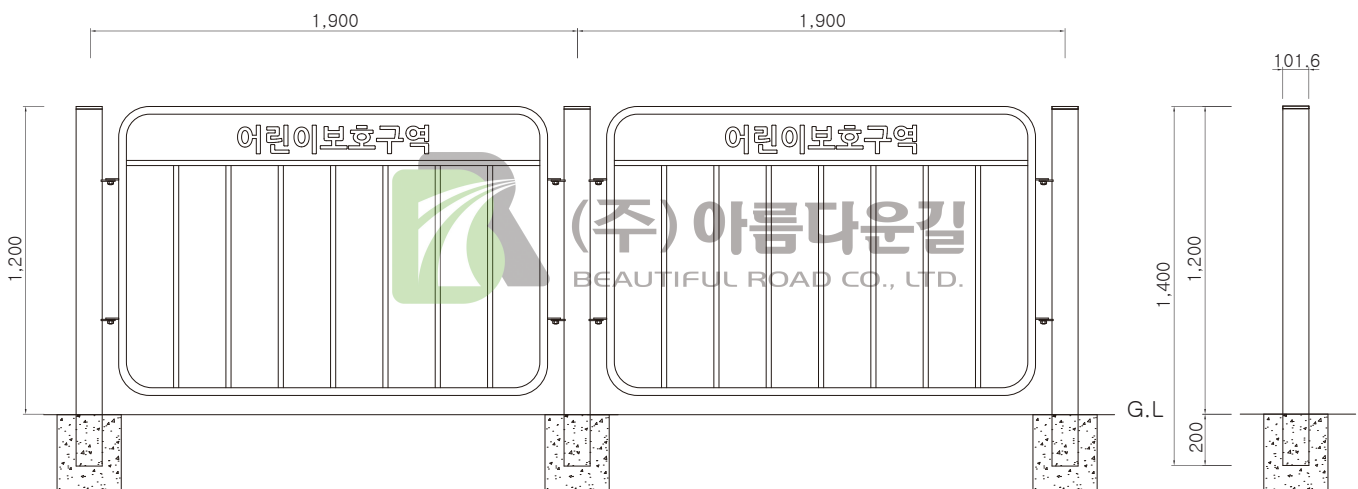

디자인형울타리

※현장설치도

Model Name	Materials	Size	G2B Number	Price
BR-F-55	STEEL/AL	W1.8 × H1.175	24657083	₩364,000/경간(VAT포함)



Dimension

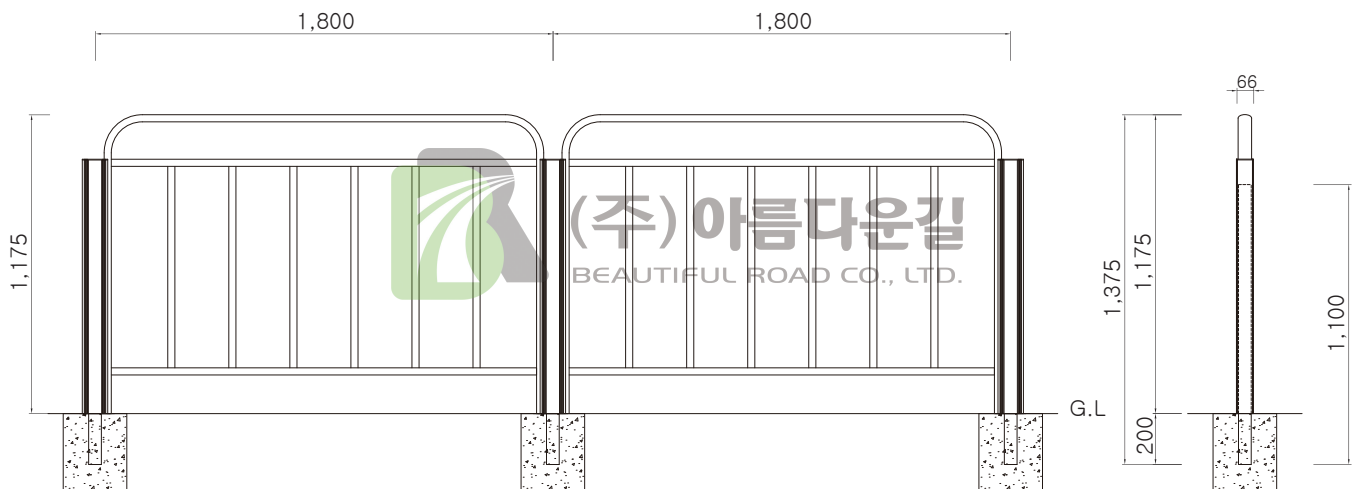

※현장설치도

Model Name	Materials	Size	G2B Number	Price
BR-F-56	STEEL/AL	W1.8 × H1.175	24657084	₩390,000/경간(VAT포함)



Dimension

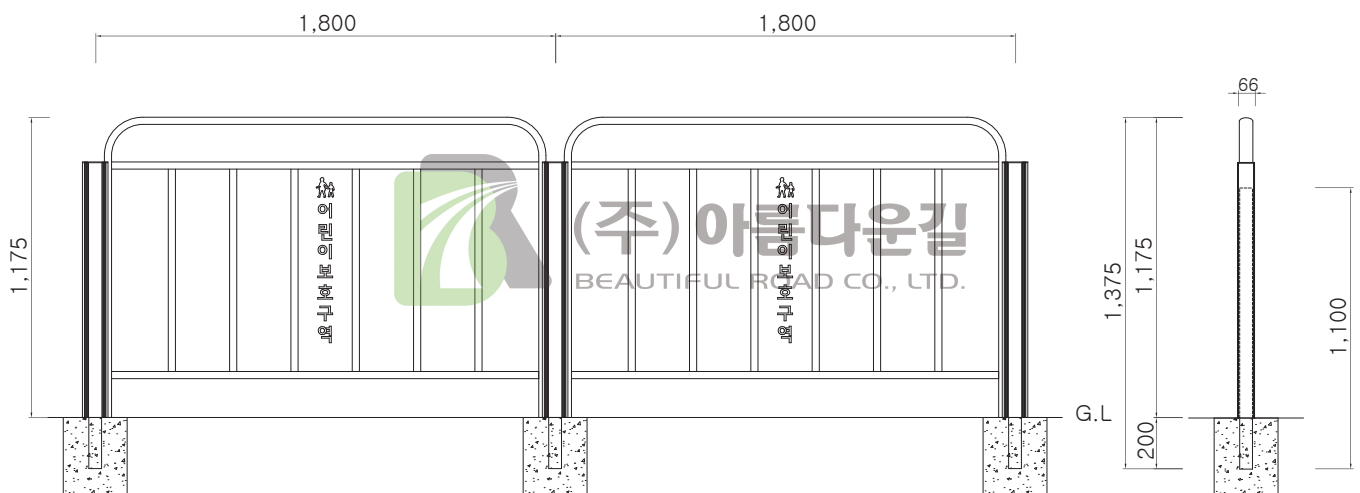

디자인형울타리

※현장설치도

Model Name	Materials	Size	G2B Number	Price
BR-F-63	STEEL	W2.0 × H1.1	24662991	₩390,000/경간(VAT포함)



Dimension

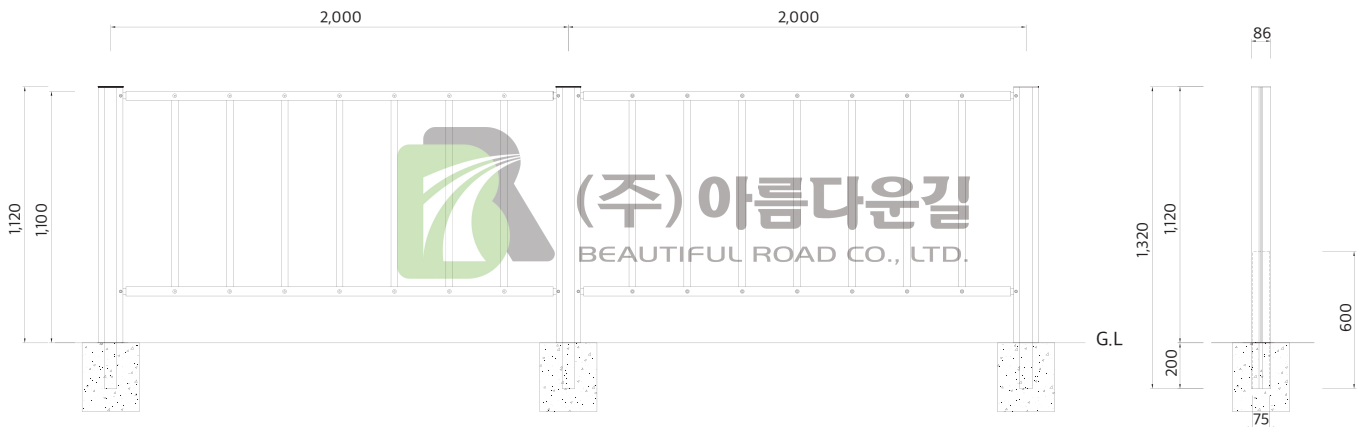

※현장설치도

Model Name	Materials	Size	G2B Number	Price
BR-FA-2	STEEL/AL	W2.0 × H1.1	24458201	₩395,000/경간(VAT포함)

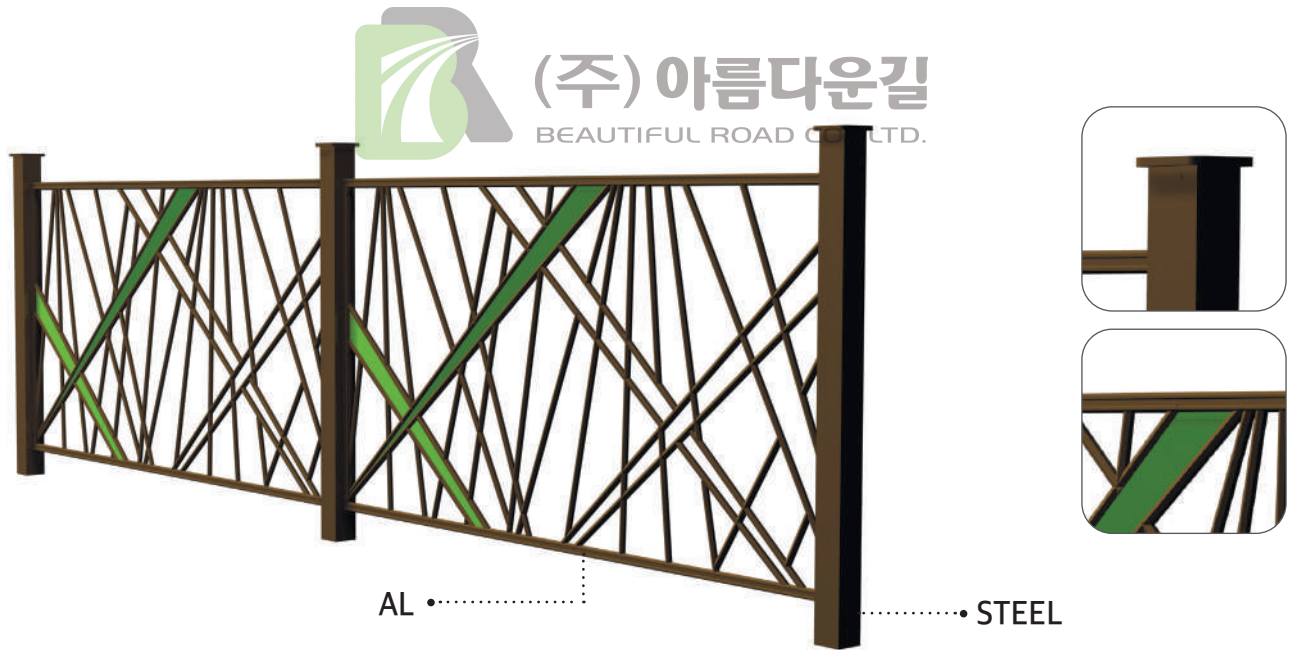

Dimension

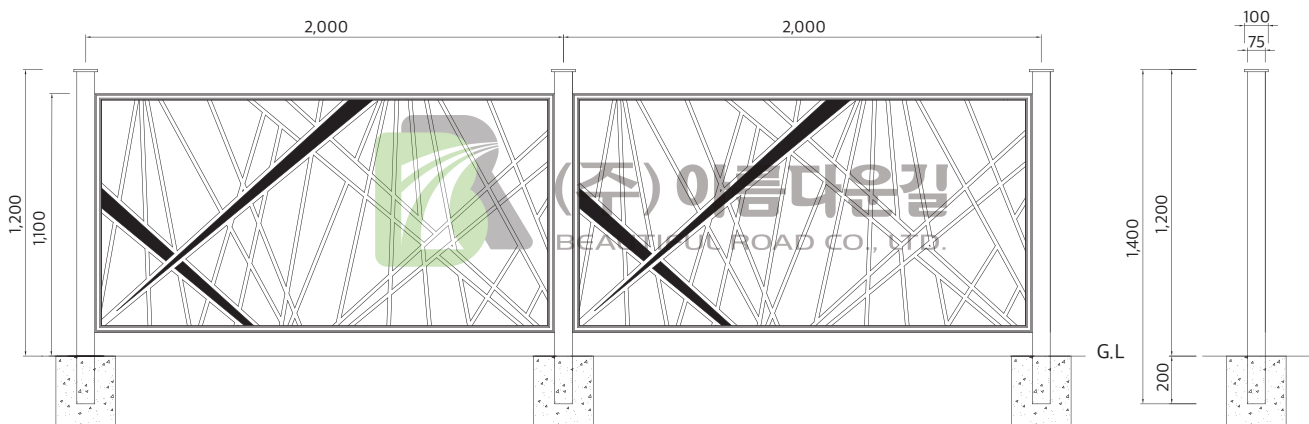

디자인형울타리

※현장설치도

Model Name	Materials	Size	G2B Number	Price
BR-F-15	STEEL	W2.0 × H1.1	24880820	₩390,000/경간(VAT포함)

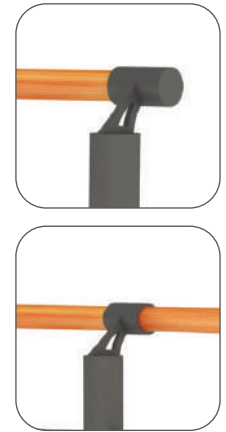

Dimension

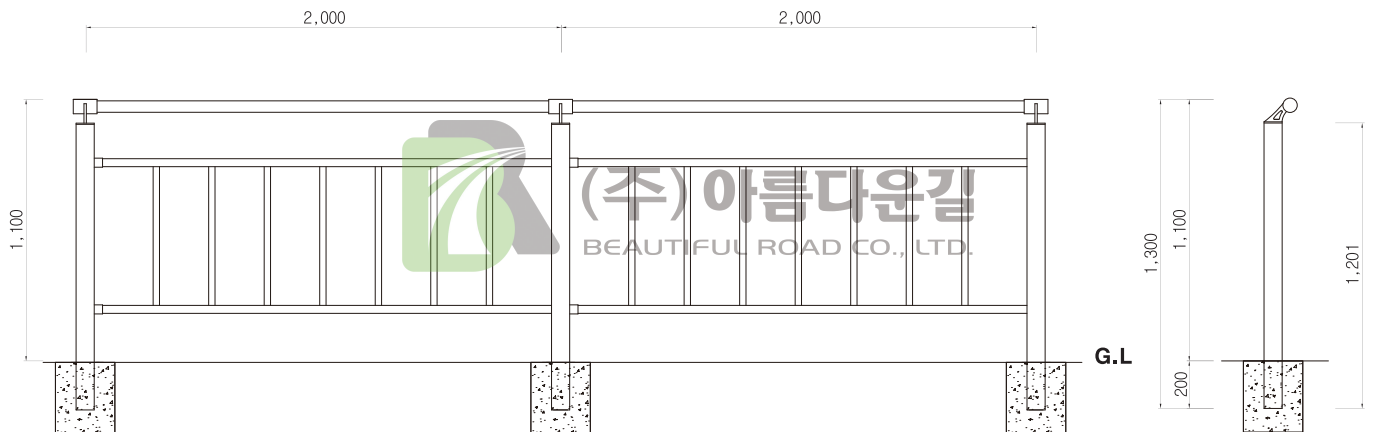

※현장설치도

Model Name	Materials	Size	G2B Number	Price
BR-F-66	STEEL	W2.0 × H1.2	24889130	₩385,000/경간(VAT포함)

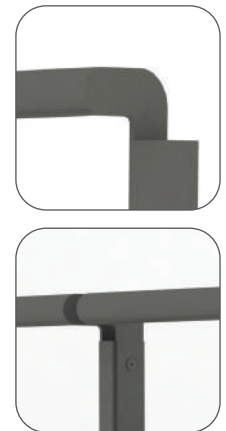

Dimension

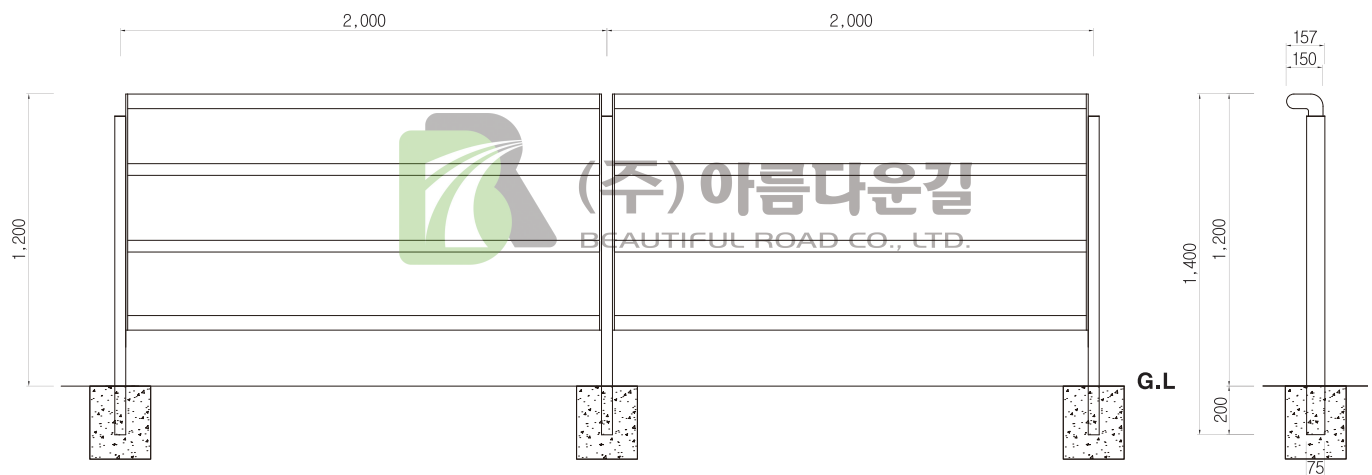

디자인형울타리

※현장설치도

Model Name	Materials	Size	G2B Number	Price
BR-F-67	STEEL	W2.0 × H1.1	24893809	₩350,000/경간(VAT포함)

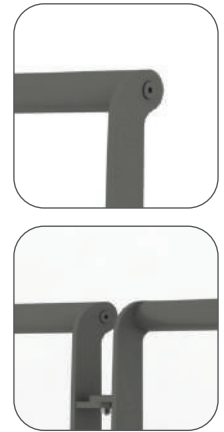

Dimension

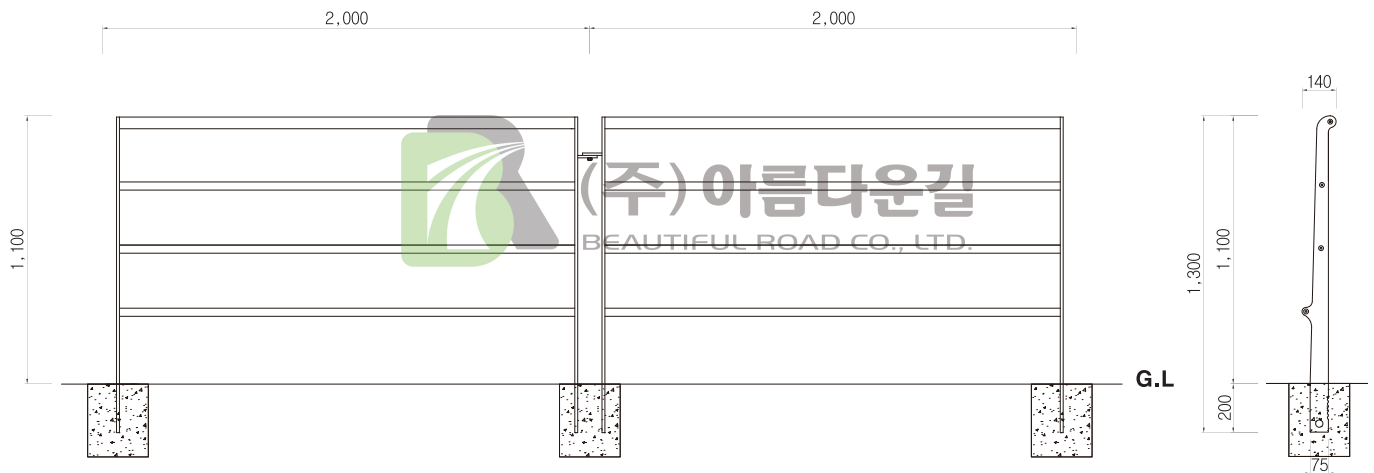

※현장설치도

Model Name	Materials	Size	G2B Number	Price
BR-F-68	STEEL	W2.0 × H1.1	24893810	₩375,000/경간(VAT포함)

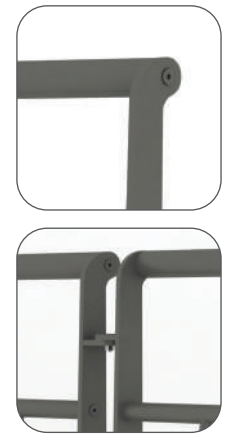

Dimension

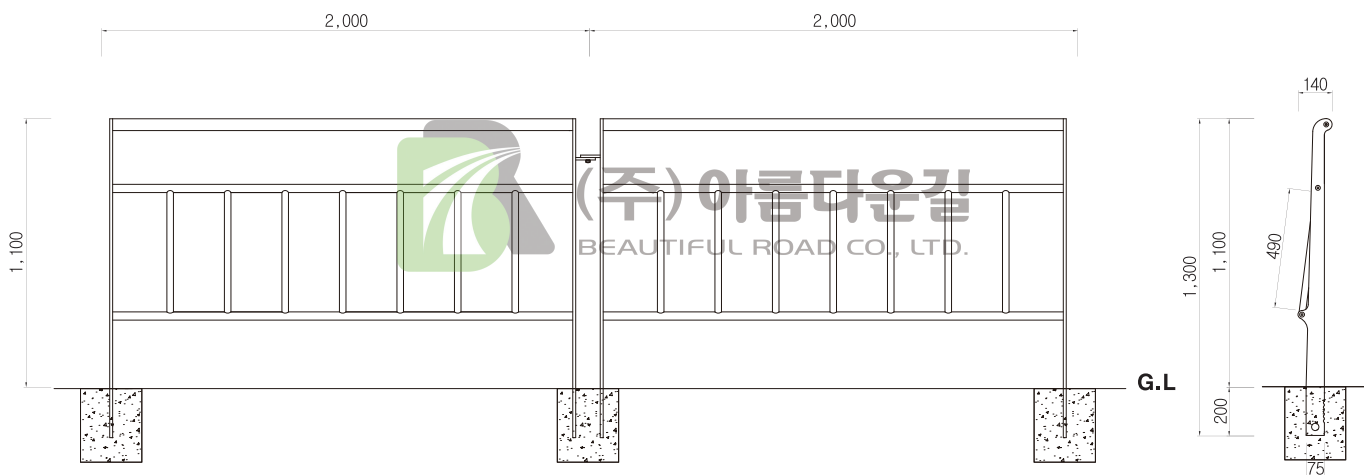

디자인형울타리

※현장설치도

Model Name	Materials	Size	G2B Number	Price
BR-F-69	STEEL	W1.8 × H1.1	24889131	₩340,000원/경간(VAT포함)



Dimension

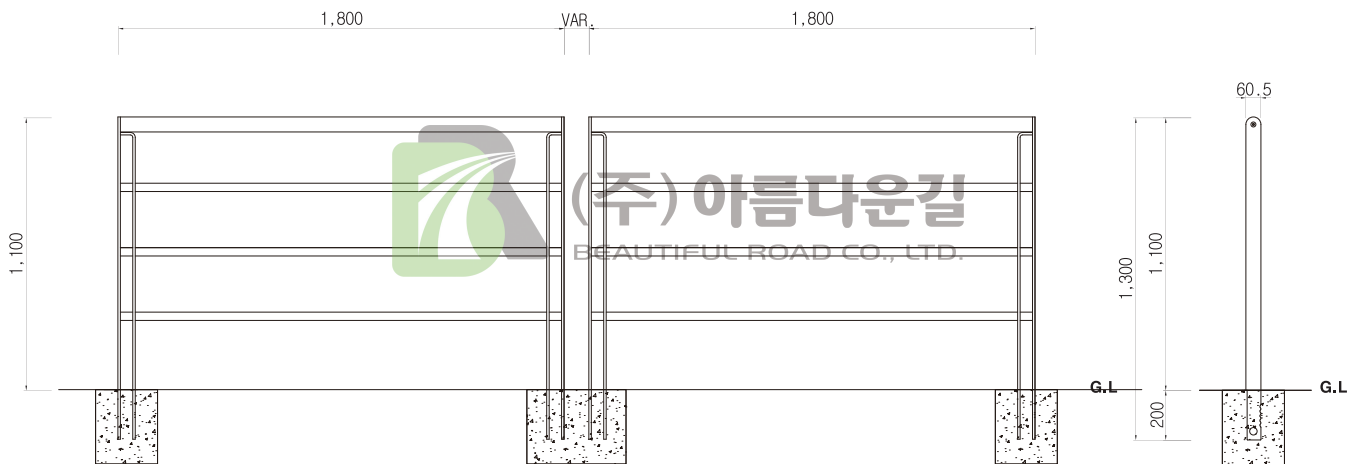

※현장설치도

Model Name	Materials	Size	G2B Number	Price
BR-F-70	STEEL	W1.8 × H1.1	24889135	₩360,000/경간(VAT포함)

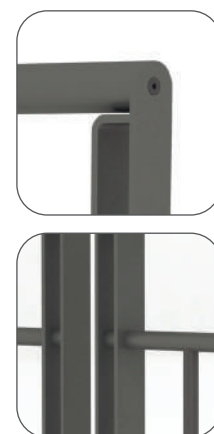

Dimension

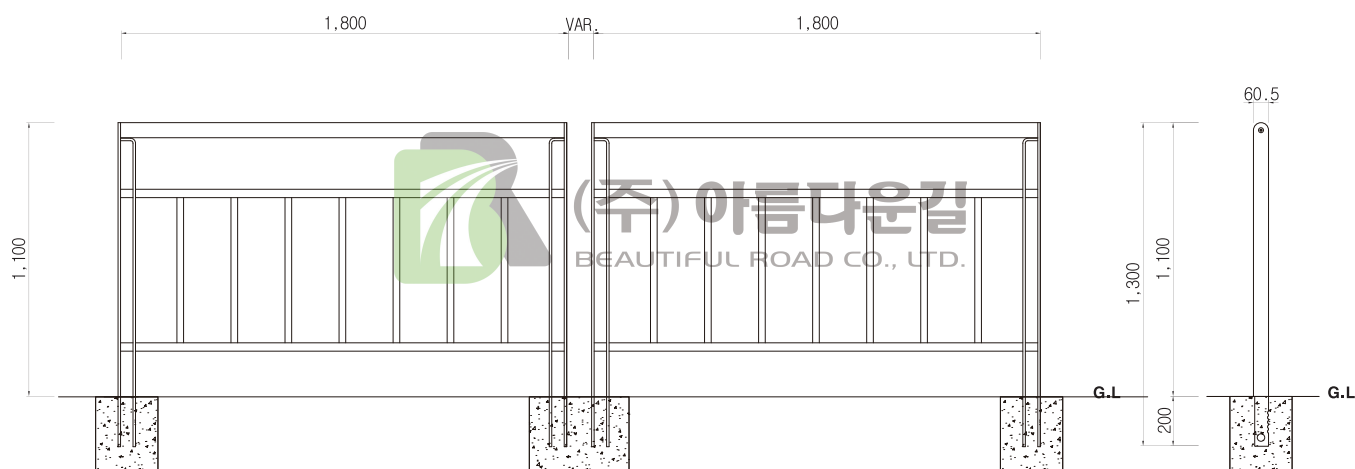

디자인형울타리

※현장설치도

Model Name	Materials	Size	G2B Number	Price
BR-FTG-1	STS/강화접합유리	W1.0 × H1.1	24814858	₩930,000원/경간(VAT포함)



Dimension

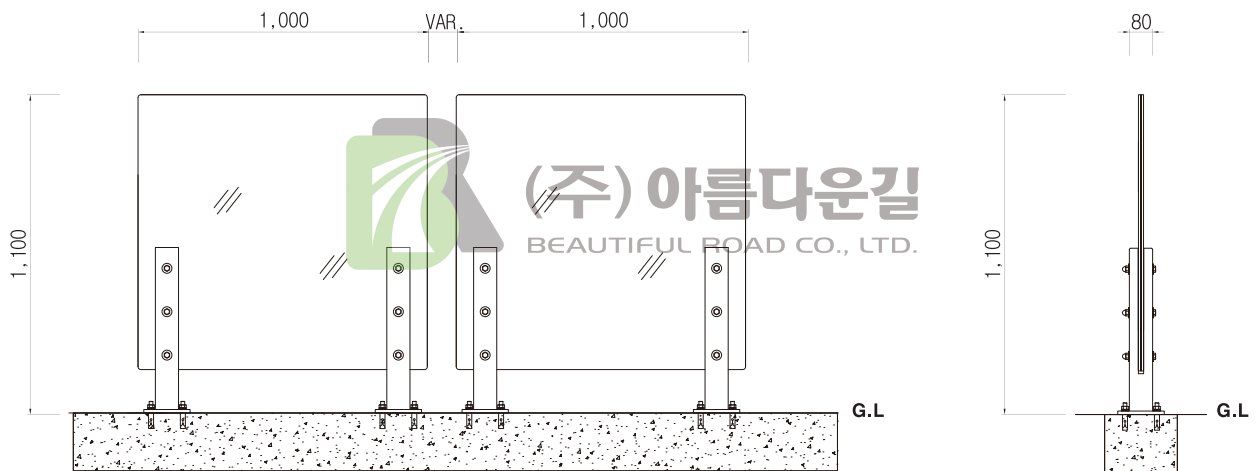

Model Name	Materials	Size	G2B Number	Price
BR-FTG-2	STS/강화접합유리	W1.1 × H1.1	24814859	₩1,000,000원/경간(VAT포함)



Dimension

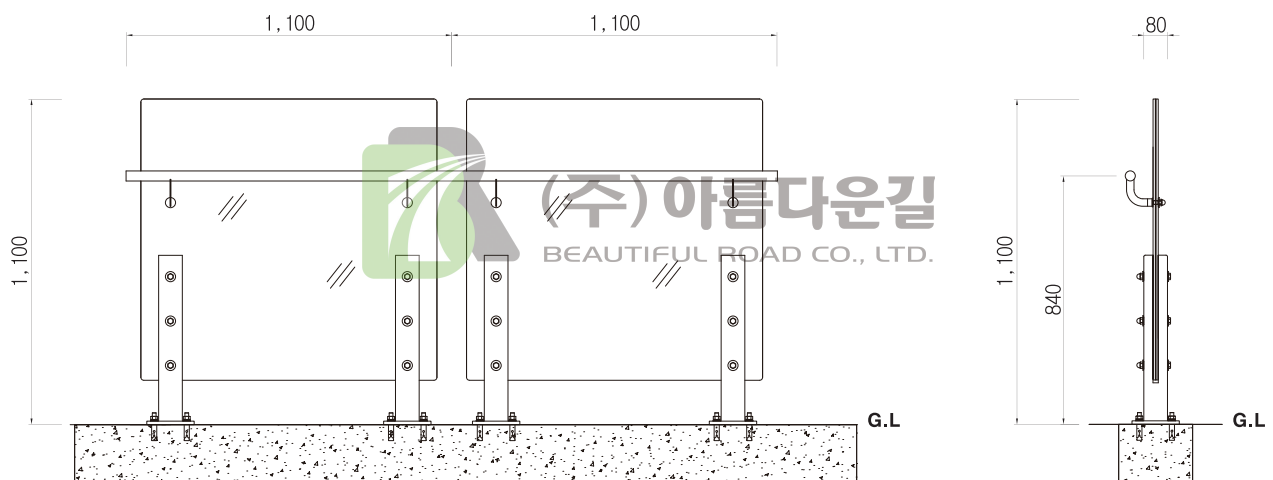

디자인형울타리

※현장설치도

Model Name	Materials	Size	G2B Number	Price
BR-FU-1	STS	W1.2 × H0.7	24864758	₩230,000원/경간(VAT포함)



Dimension

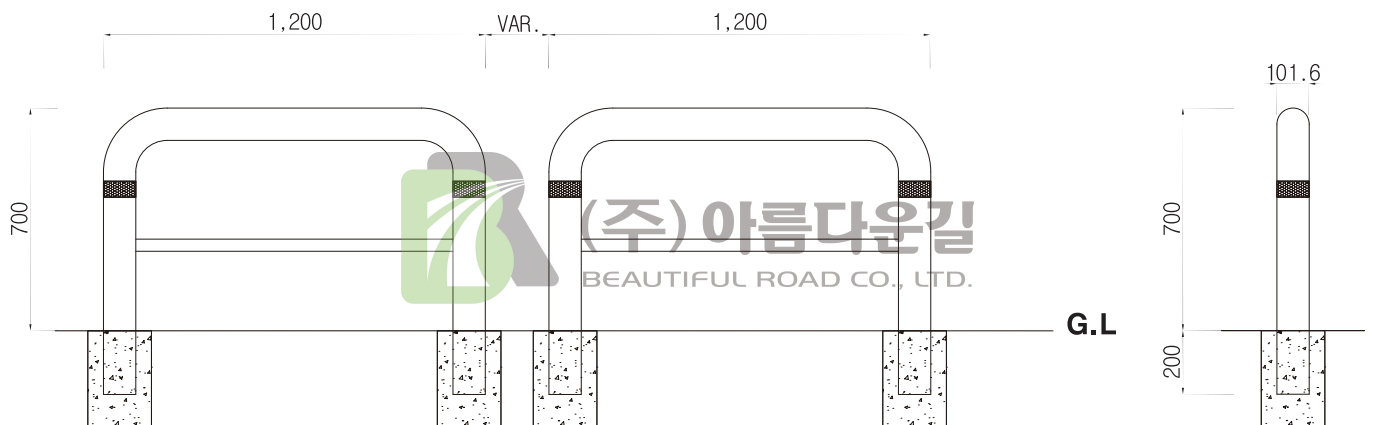

BOLLARD



(주) 아름다운길
BEAUTIFUL ROAD CO., LTD.



(주) 아름다운길
BEAUTIFUL ROAD CO., LTD.



(주) 아름다운길
BEAUTIFUL ROAD CO., LTD.

볼라드

Model Name	Materials	Size	G2B Number	Price
BR-UBL-1	STAINLESS	Φ101.6 × 1200 × 700 U형, 매립식	24318248	₩215,000원/개(VAT포함, 현장설치도)
				₩175,000원/개(VAT포함, 납품하차도)

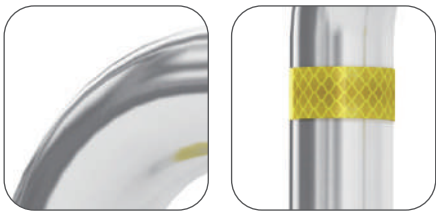

Dimension

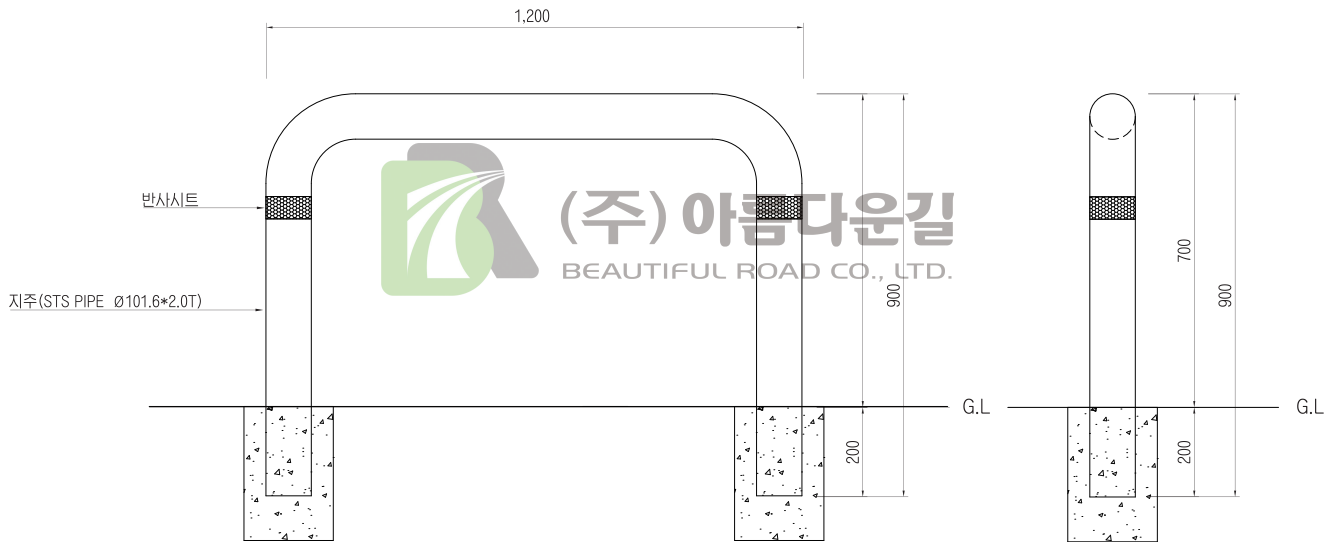

Example of Construction



볼라드

Model Name	Materials	Size	G2B Number	Price
BR-UBL-2	STAINLESS	Φ101.6 × 1500 × 700 U형, 매립식	24318249	₩230,000원/개(VAT포함, 현장설치도)
				₩185,000원/개(VAT포함, 납품하차도)



Dimension

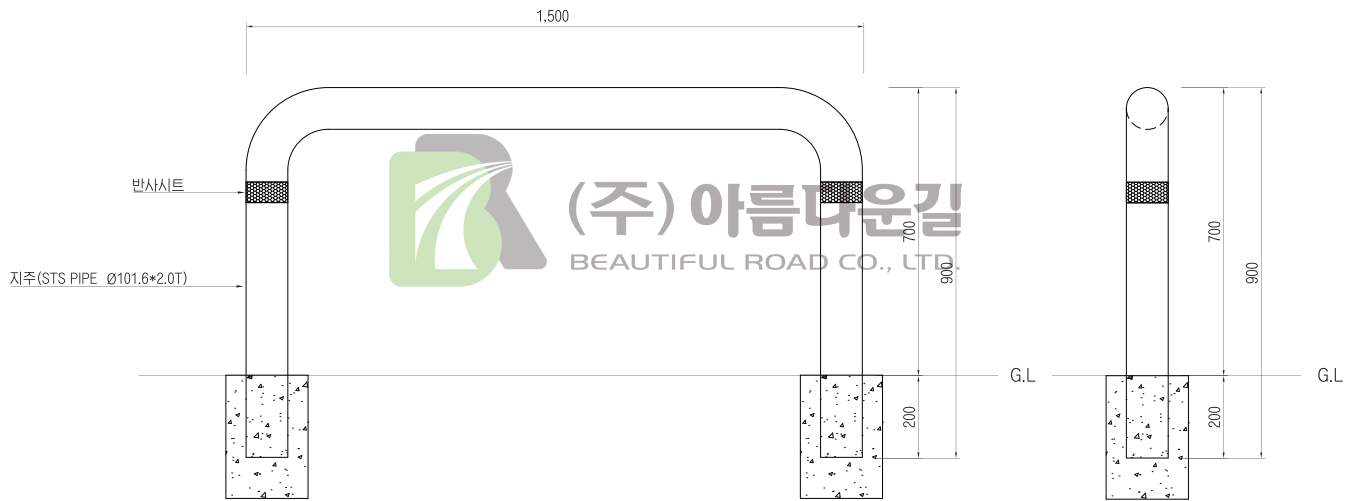

Example of Construction

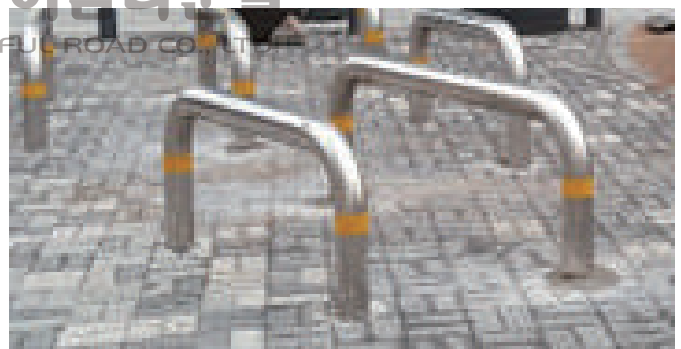

볼라드

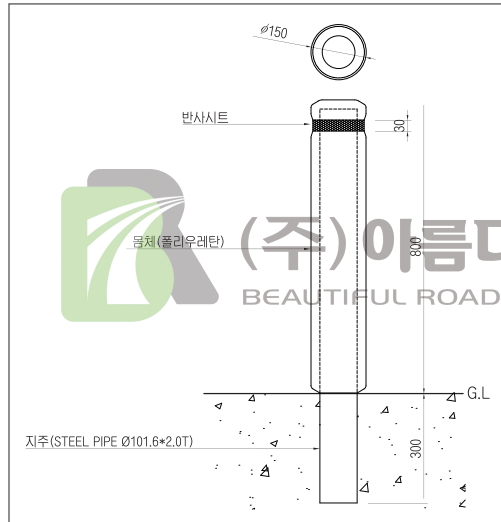

Model Name	Size	G2B Number	Price
BR-BL-2	Ø150 × 800 / 매립식	24318237	₩208,000원/개(VAT포함, 현장설치도)
			₩178,000원/개(VAT포함, 납품하차도)

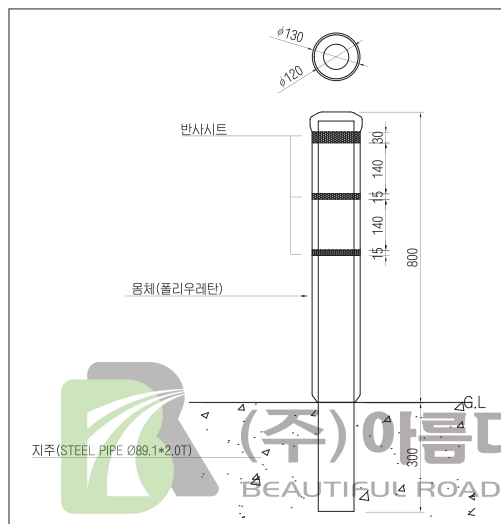

Model Name	Size	G2B Number	Price
BR-BL-3	Ø120 × 800 / 매립식	24318239	₩205,000원/개(VAT포함, 현장설치도)
			₩175,000원/개(VAT포함, 납품하차도)

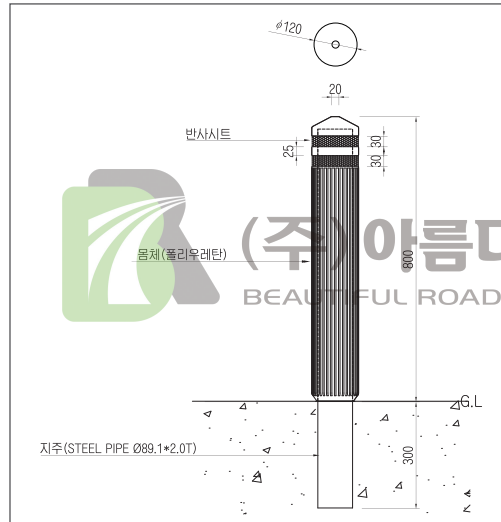

Model Name	Size	G2B Number	Price
BR-BL-4	$\phi 120 \times 800$ / 매립식	24318240	₩205,000원/개(VAT포함, 현장설치도)
			₩175,000원/개(VAT포함, 납품하차도)

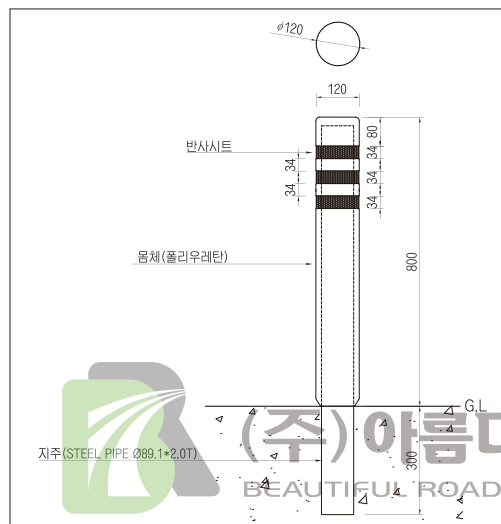

Model Name	Size	G2B Number	Price
BR-BL-5	$\phi 120 \times 800$ / 매립식	24318245	₩205,000원/개(VAT포함, 현장설치도)
			₩175,000원/개(VAT포함, 납품하차도)

볼라드

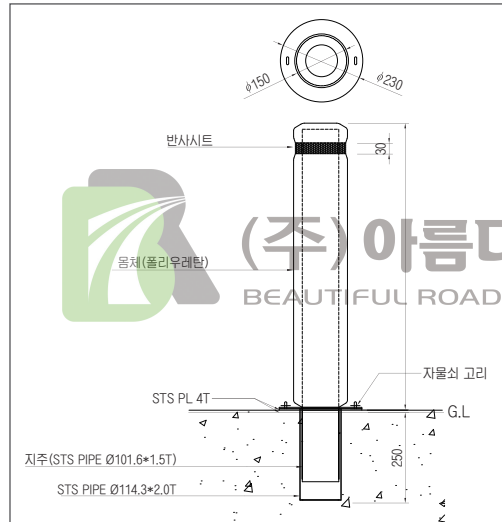

Model Name	Size	G2B Number	Price
BR-BL-2M	Ø150 × 800 / 이동식	24318238	₩285,000원/개(VAT포함, 현장설치도)
			₩255,000원/개(VAT포함, 납품하차도)

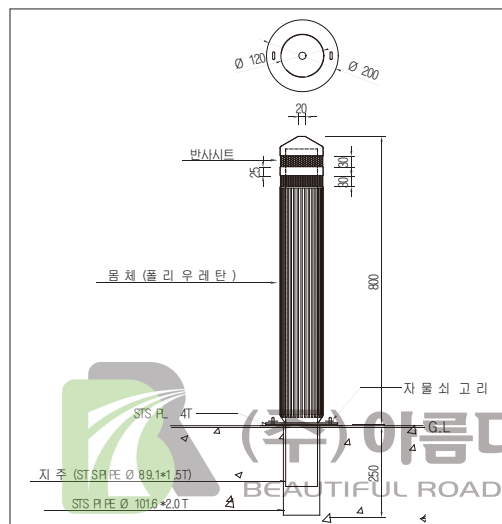
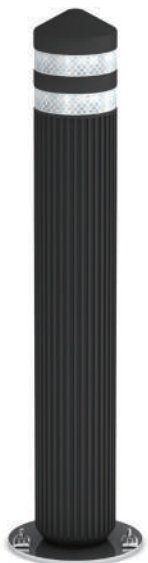

Model Name	Size	G2B Number	Price
BR-BL-4M	Ø120 × 800 / 이동식	24318244	₩282,000원/개(VAT포함, 현장설치도)
			₩252,000원/개(VAT포함, 납품하차도)

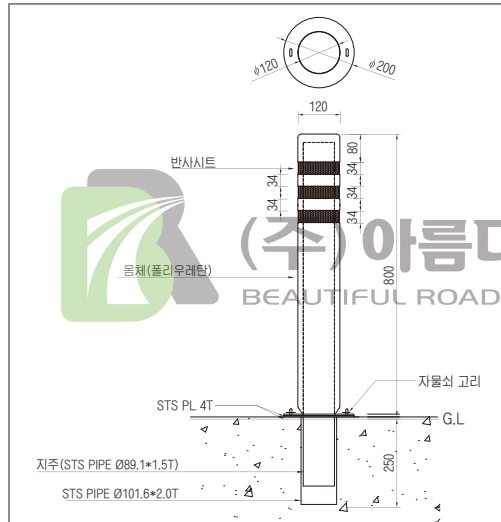

Model Name	Size	G2B Number	Price
BR-BL-5M	Φ120 × 800 / 이동식	24318246	₩282,000원/개(VAT포함, 현장설치도)
			₩252,000원/개(VAT포함, 납품하차도)

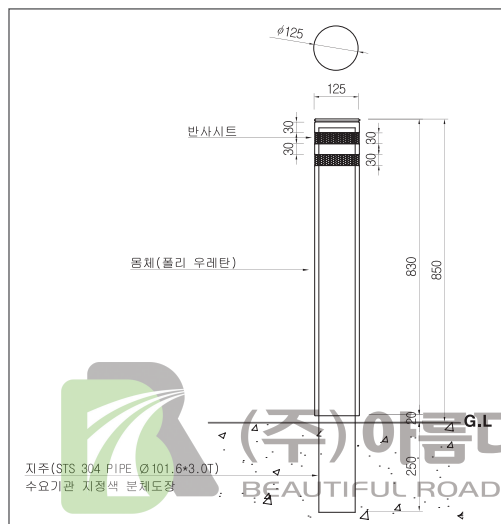

Model Name	Size	G2B Number	Price
BR-BL-6	Φ125 × 850 / 매립식	24318247	₩240,000원/개(VAT포함, 현장설치도)
			₩210,000원/개(VAT포함, 납품하차도)

볼라드

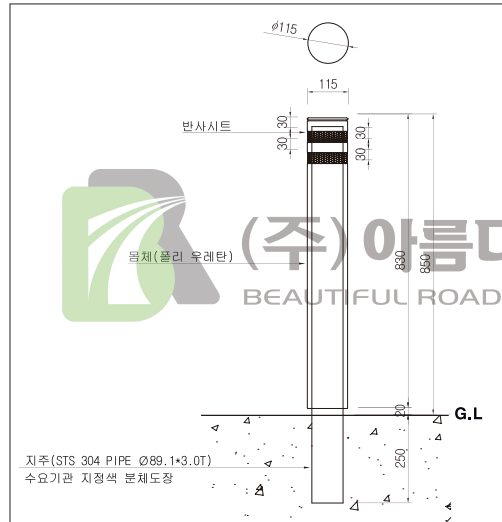

Model Name	Size	G2B Number	Price
BR-BL-7	Φ115 × 850 / 매립식	24895772	₩233,000원/개(VAT포함, 현장설치도)
			₩203,000원/개(VAT포함, 납품하차도)

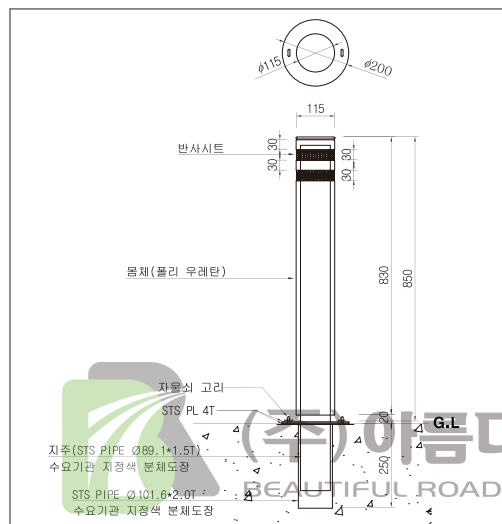

Model Name	Size	G2B Number	Price
BR-BL-7M	Φ115 × 850 / 이동식	24895773	₩270,000원/개(VAT포함, 현장설치도)
			₩240,000원/개(VAT포함, 납품하차도)

버스승강장



(주) 아름다운길
BEAUTIFUL ROAD CO., LTD.

BUS SHELTER



(주) 아름다운길
BEAUTIFUL ROAD CO., LTD.



(주) 아름다운길
BEAUTIFUL ROAD CO., LTD.

버스승강장

※현장설치도

Model Name	Materials	Size	G2B Number	Price
BR-BS-7	STEEL/강화유리	8000 × 2000 × 2900	24701654	₩12,450,000/조(VAT 포함)



Dimension

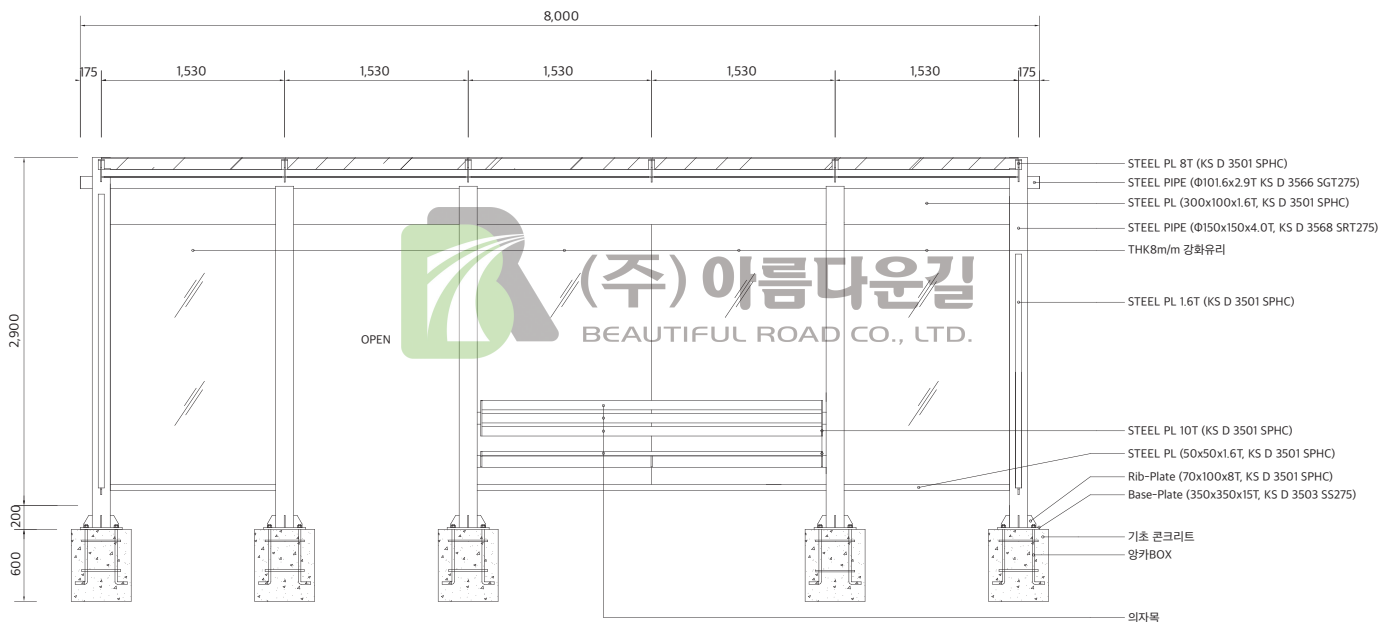

※현장설치도

Model Name	Materials	Size	G2B Number	Price
BR-BS-8	STEEL/강화유리	5000 × 2000 × 2900	24701655	₩9,700,000/조(VAT포함)



Dimension

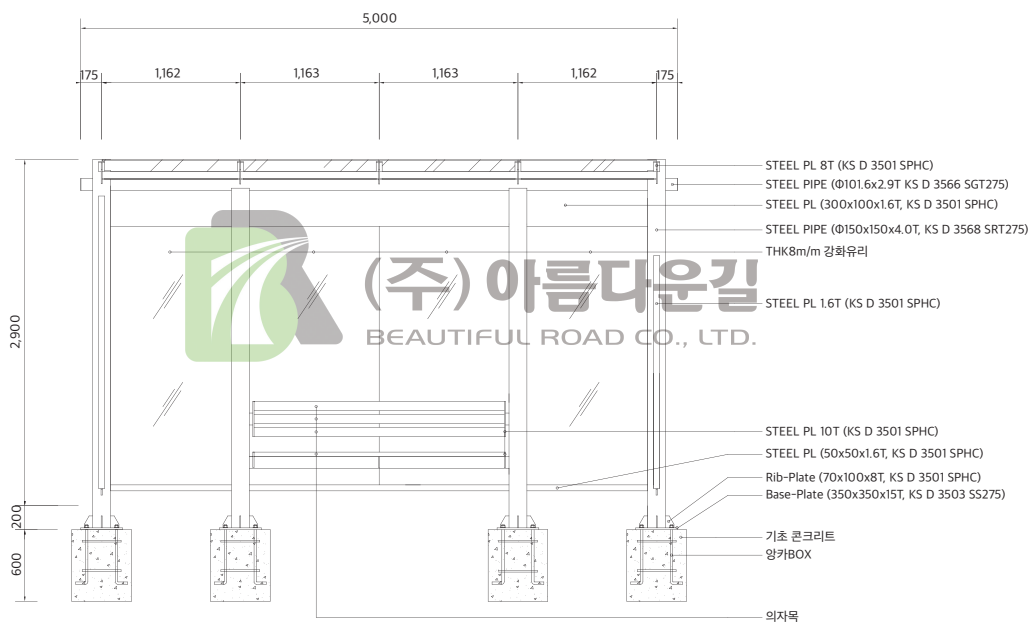

버스승강장

※현장설치도

Model Name	Materials	Size	G2B Number	Price
BR-BS-9	STEEL/강화유리	4000 × 2000 × 2900	24701656	₩8,500,000/조(VAT포함)



Dimension

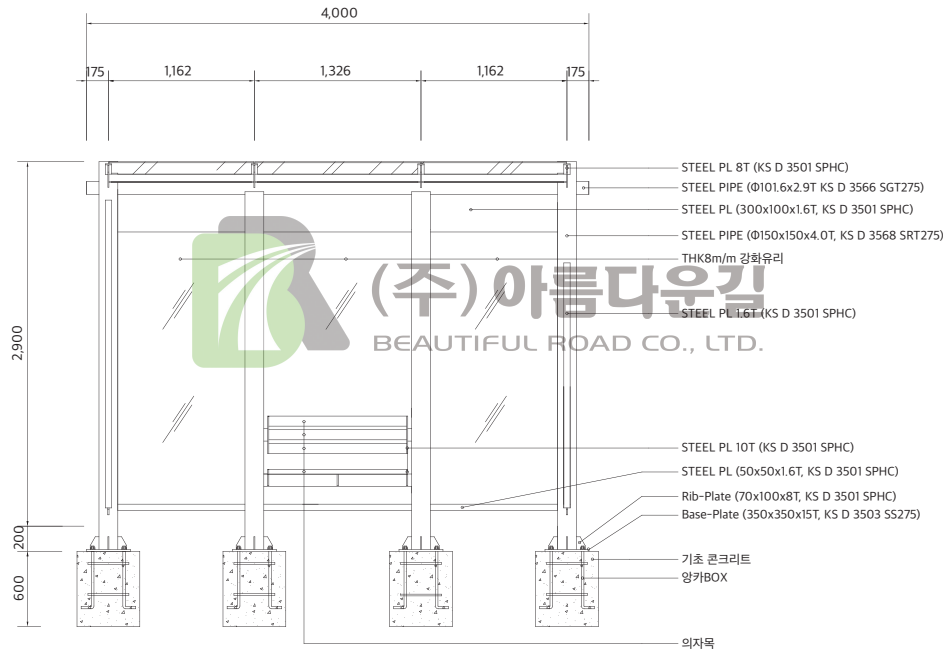

※현장설치도

Model Name	Materials	Size	G2B Number	Price
BR-BS-10	STEEL/강화유리	3000 × 1400 × 2900	24701657	₩5,200,000/조(VAT포함)



Dimension

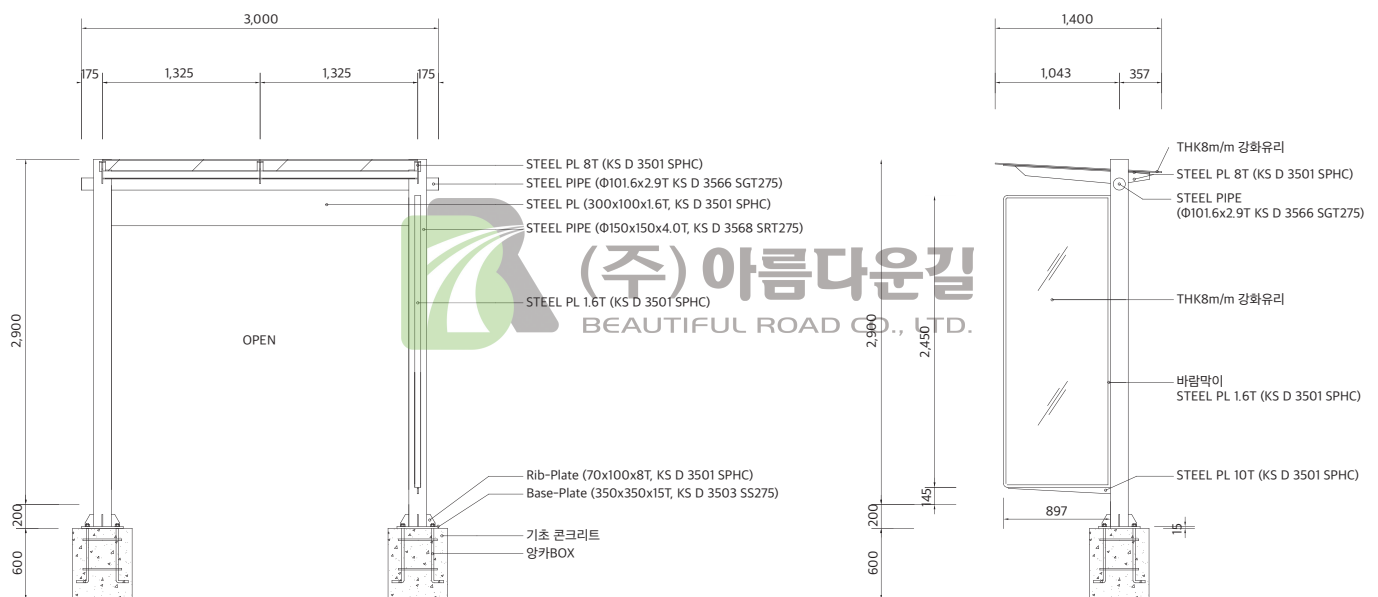

버스승강장

※현장설치도

Model Name	Materials	Size	G2B Number	Price
BR-BS-11	STEEL/강화유리	3000 × 1400 × 3500	24701658	₩7,850,000/조(VAT포함)



Dimension

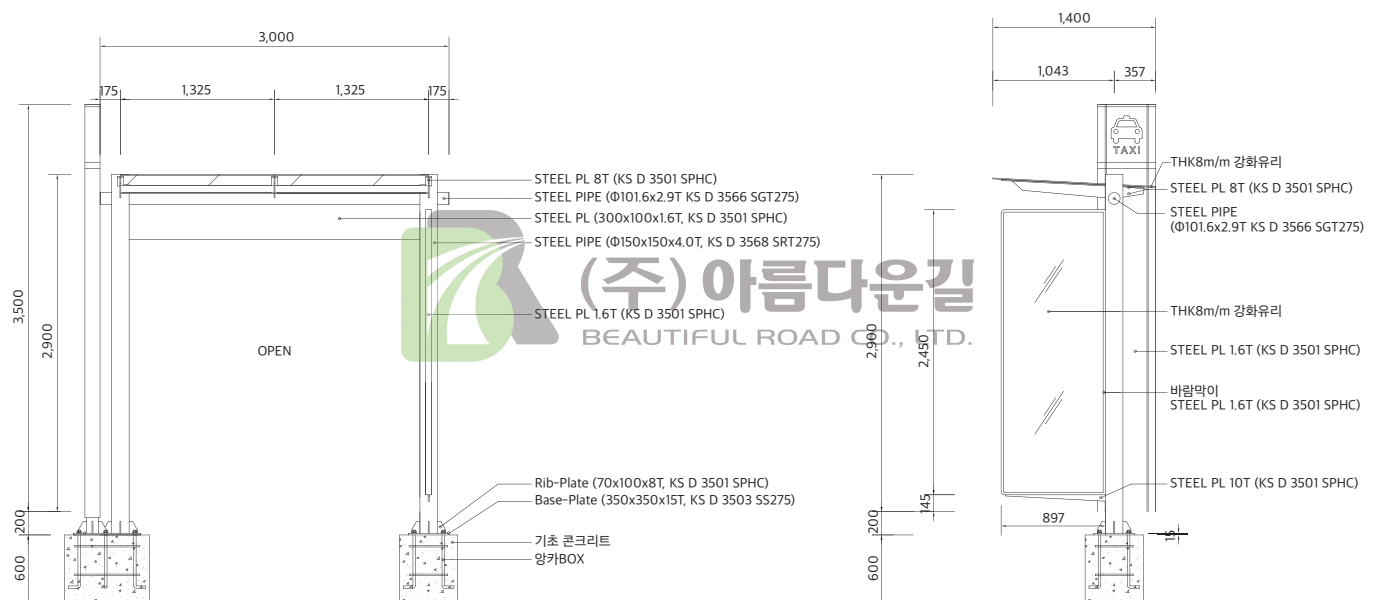

※현장설치도

Model Name	Materials	Size	G2B Number	Price
BR-BS-12	AL/강화유리	9810 × 2000 × 2850	24736033	₩23,610,000/조(VAT포함)



Dimension

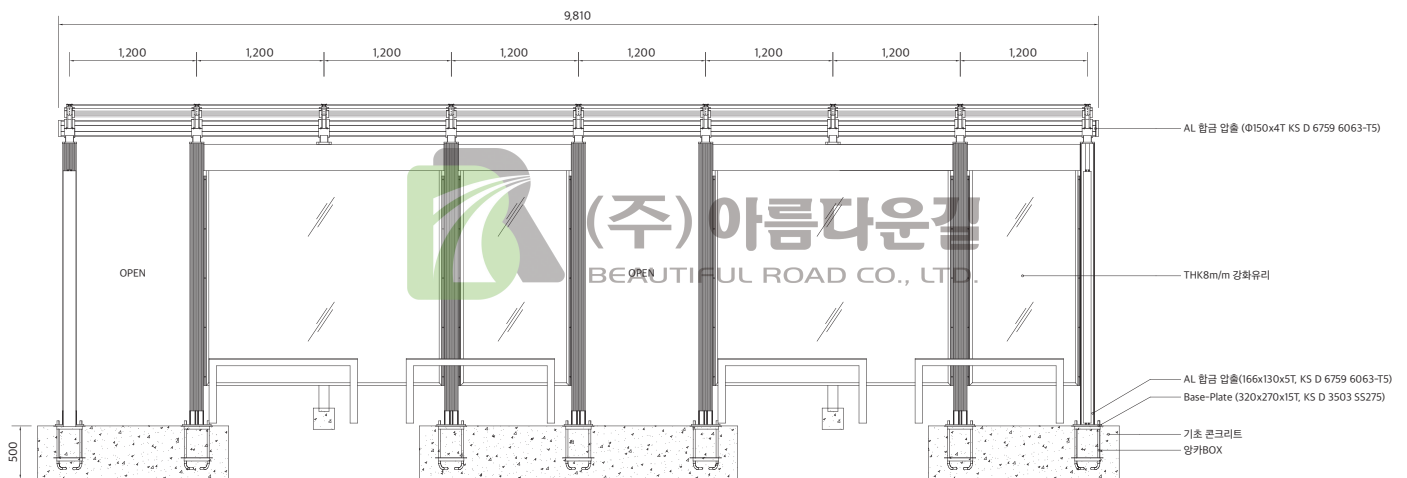

버스승강장

※현장설치도

Model Name	Materials	Size	G2B Number	Price
BR-BS-13	AL/강화유리	5010 × 2000 × 2850	24736034	₩13,795,000/조(VAT포함)



Dimension

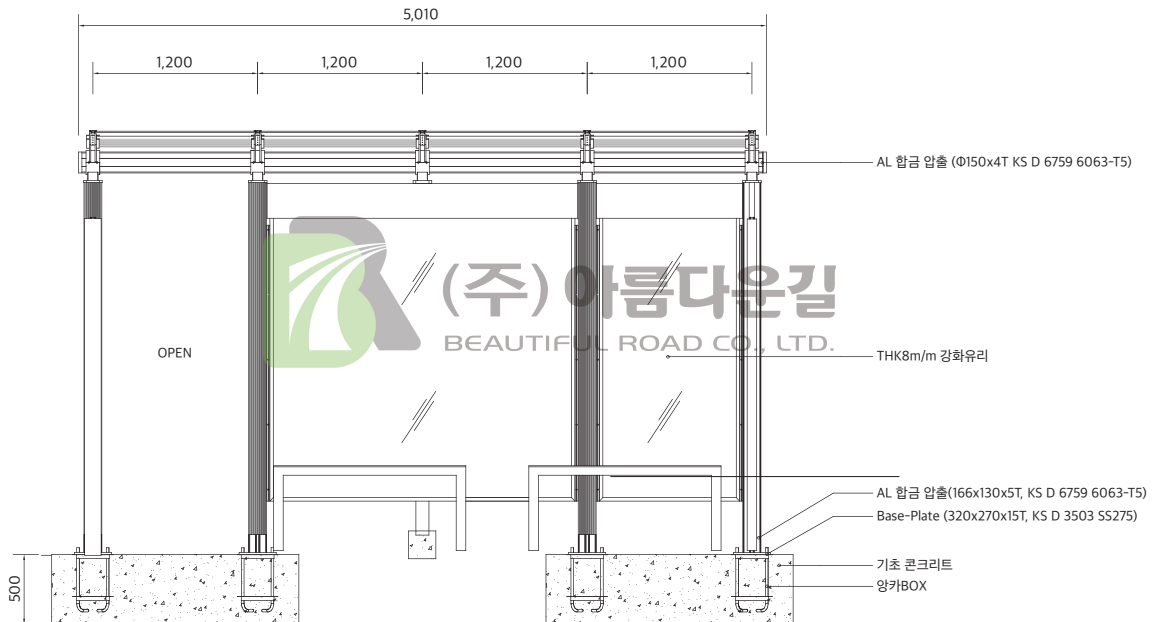

※현장설치도

Model Name	Materials	Size	G2B Number	Price
BR-BS-14	AL/강화유리	5010 × 2000 × 2850	24736035	₩16,450,000/조(VAT포함)



Dimension

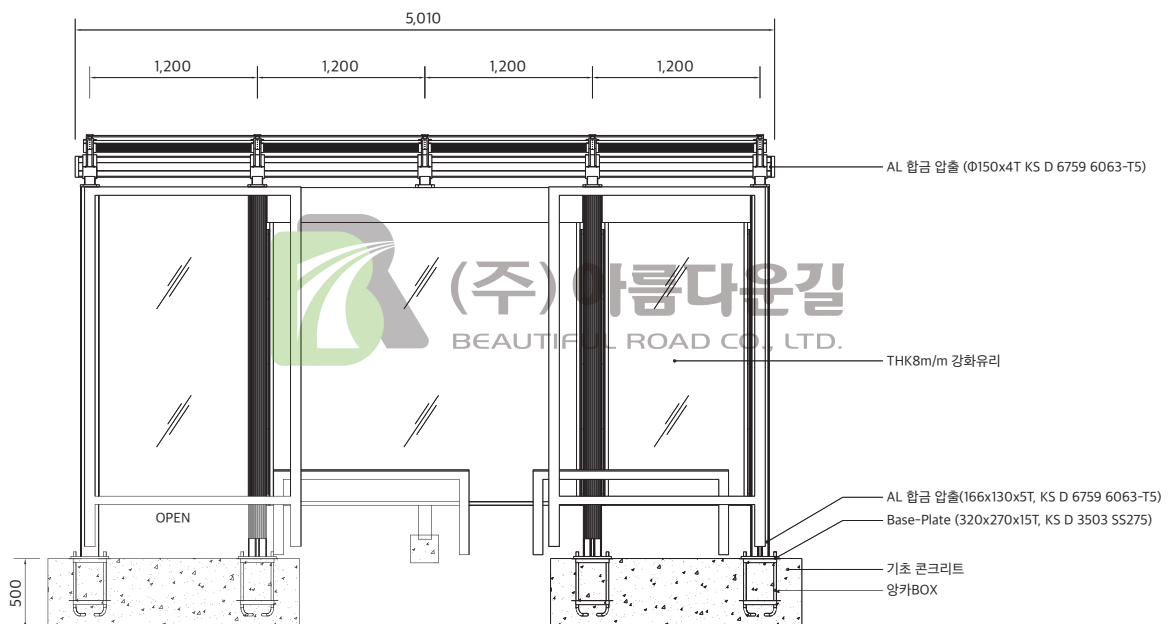

버스승강장

※현장설치도

Model Name	Materials	Size	G2B Number	Price
BR-BS-15	AL/강화유리	5010 × 1800 × 2850	24736036	₩13,795,000/조(VAT포함)



Dimension

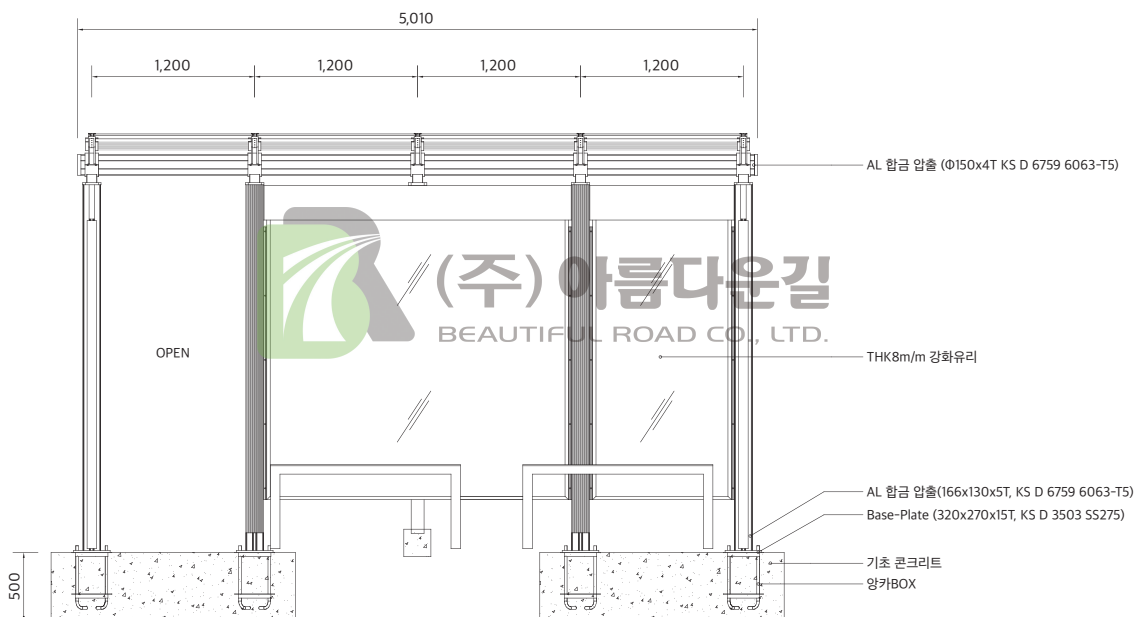

※현장설치도

Model Name	Materials	Size	G2B Number	Price
BR-BS-16	AL/강화유리	3810 × 2000 × 2850	24736037	₩10,590,000/조(VAT포함)



Dimension

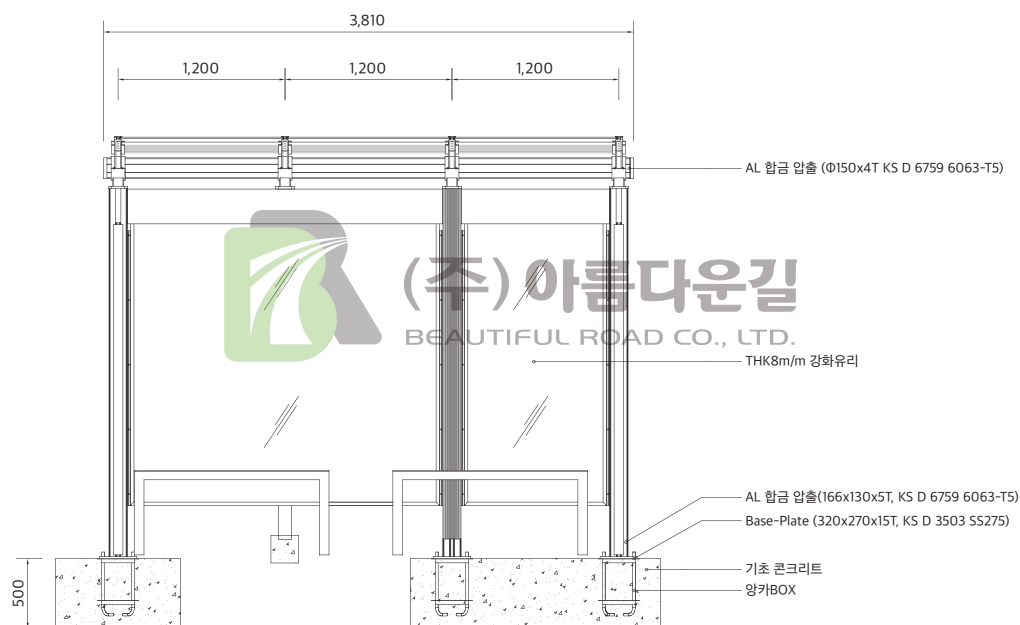

버스승강장

※현장설치도

Model Name	Materials	Size	G2B Number	Price
BR-BS-17	AL/강화유리	2610 × 2000 × 2850	24736038	₩8,598,000/조(VAT포함)



Dimension

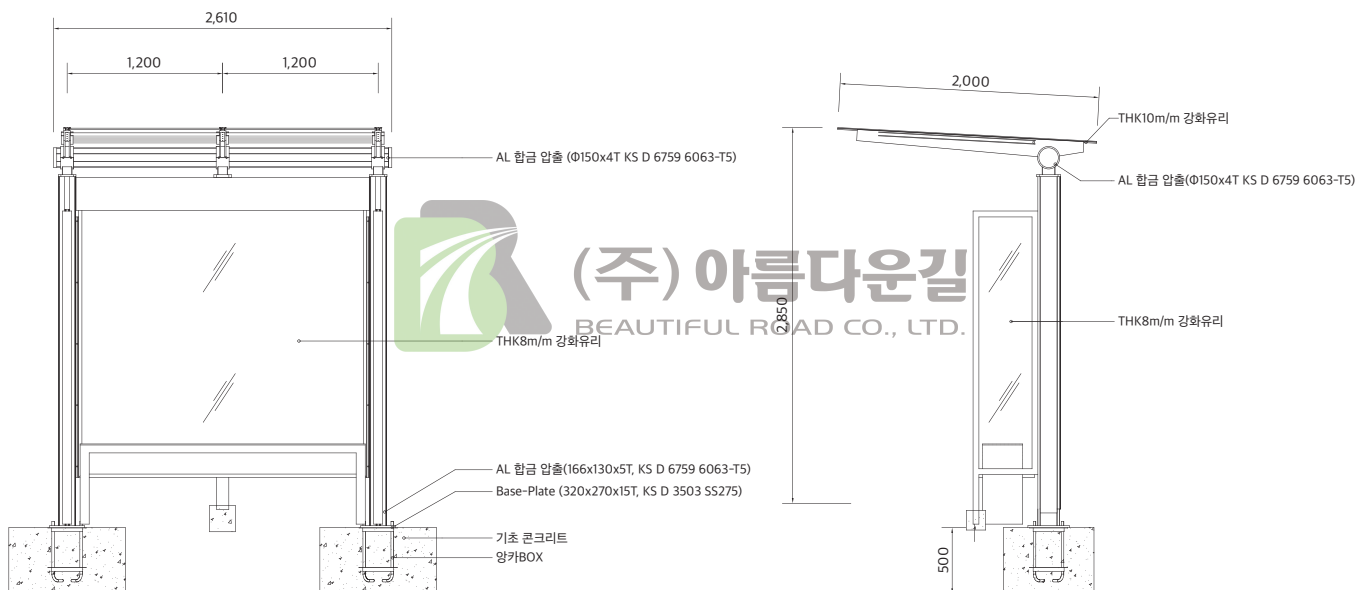

자전거보관대



(주) 아름다운길
BEAUTIFUL ROAD CO., LTD.

BICYCLE RACK



(주) 아름다운길
BEAUTIFUL ROAD CO., LTD.



(주) 아름다운길
BEAUTIFUL ROAD CO., LTD.

※현장설치도

Model Name	Materials	Size	G2B Number	Price
BR-BR-2	STAINLESS	4000 × 400 × 480	24665615	₩600,000/개(VAT포함)

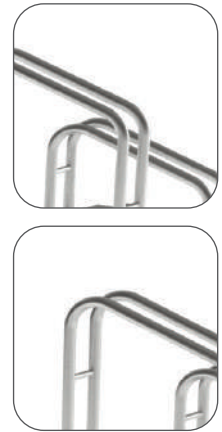
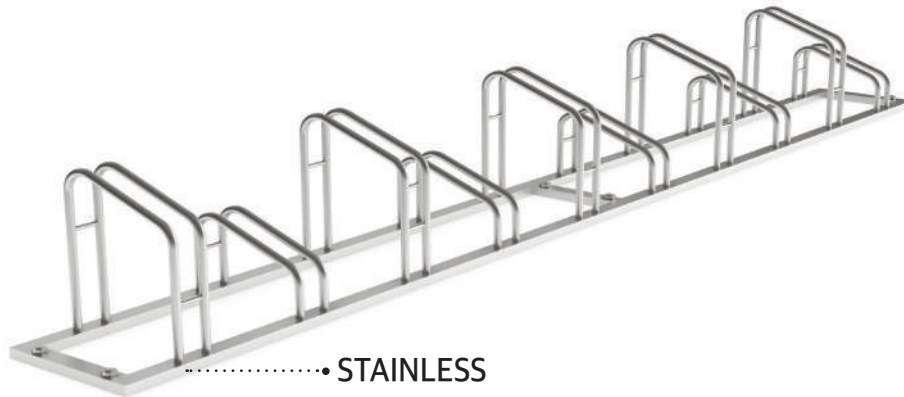

Dimension

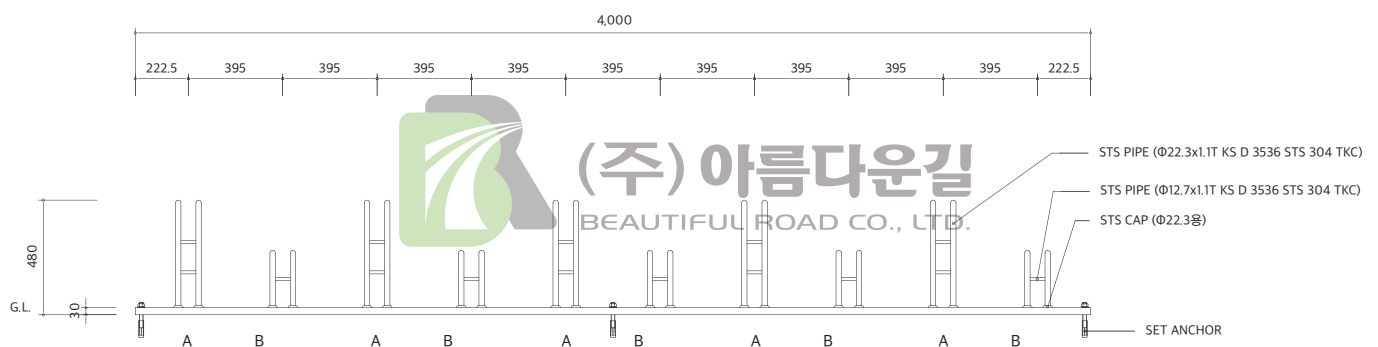

자전거보관대

※현장설치도

Model Name	Materials	Size	G2B Number	Price
BR-BR-3	STEEL/STS /강화유리	3200 × 1600 × 2100	24665616	₩4,200,000/조(VAT포함)

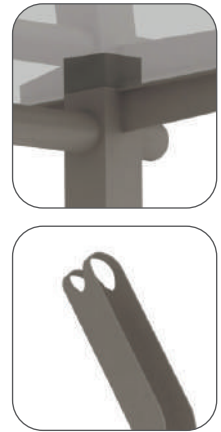

Dimension

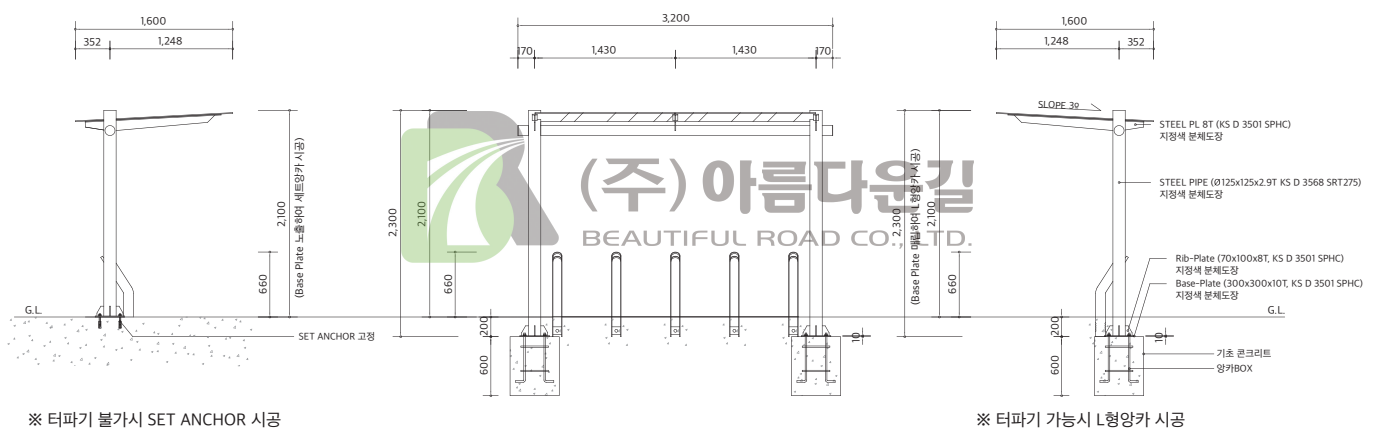

※ 터파기 불가시 SET ANCHOR 시공

※ 터파기 가능시 L형양카 시공

※현장설치도

Model Name	Materials	Size	G2B Number	Price
BR-BR-4	STAINLESS	96 × 333 × 660	24665617	₩200,000/개(VAT포함)



Dimension

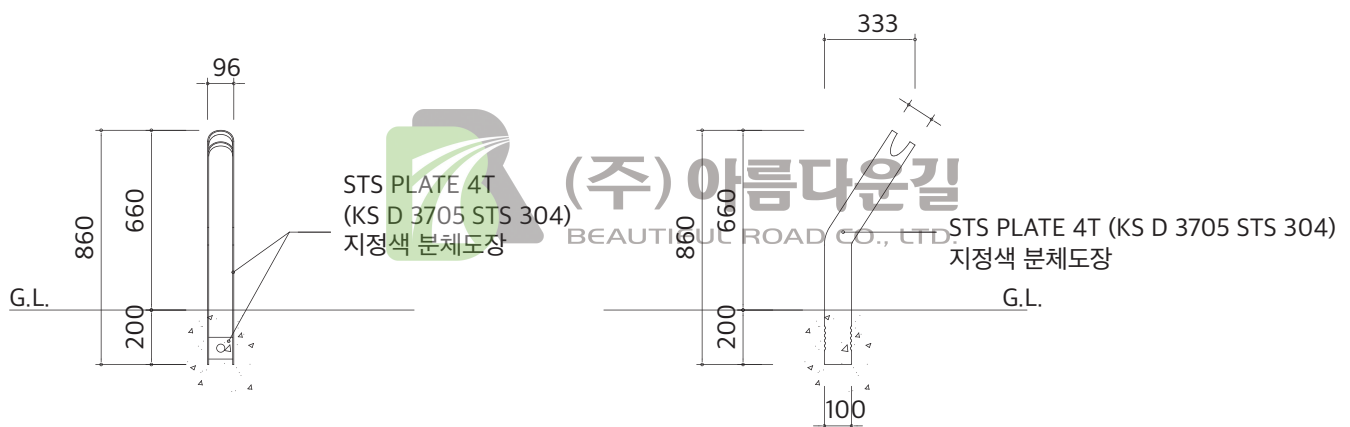



BEAUTIFUL R O A D



조달



PROCUREMENT

(주)아름다운길

BEAUTIFUL ROAD CO., LTD.



(주)아름다운길

BEAUTIFUL ROAD CO., LTD.



(주)아름다운길

BEAUTIFUL ROAD CO., LTD.











알루미늄제교량난간

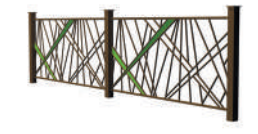

대표이미지	모델명	G2B식별번호	규격	TYPE	단가	인도조건
	BR-ABF-1	24771640	W2.0 × H1.1		280,000	현장설치도
	BR-ABF-2	24771641	W2.0 × H1.2		300,000	현장설치도
	BR-ABF-3	24771642	W2.0 × H1.2		270,000	현장설치도
	BR-F-62	24662990	W2.0 × H1.1	연결형	340,000	현장설치도
	BR-F-59	24880818	W1.8 × H1.1	연결형	360,000	현장설치도
	BR-F-3	24318690	W1.8 × H1.1	연결형	361,000	현장설치도
	BR-F-5	24318691	W1.8 × H1.1	연결형	315,000	현장설치도
	BR-F-17	24324643	W2.0 × H1.1	독립형	355,000	현장설치도
	BR-F-18	24324644	W2.0 × H1.1	독립형	380,000	현장설치도

디자인형울타리 |

대표이미지	모델명	G2B식별번호	규격	TYPE	단가	인도조건
	BR-F-39	24318692	W1.8 × H1.1	독립형	345,000	현장설치도
	BR-F-40	24318693	W1.8 × H1.1	연결형	303,000	현장설치도
	BR-F-41	24318694	W2.0 × H1.1	연결형	335,000	현장설치도
	BR-F-42	24318695	W1.8 × H1.1	독립형	370,000	현장설치도
	BR-F-44	24318696	W1.8 × H1.1	독립형	340,000	현장설치도
	BR-FA-1	24318697	W2.0 × H1.2	연결형	455,000	현장설치도
	BR-F-26	24450508	W1.8 × H1.2	독립형	285,000	현장설치도
	BR-F-47	24657081	W1.8 × H1.1	독립형	340,000	현장설치도
	BR-F-48	24657082	W1.8 × H1.1	독립형	360,000	현장설치도
	BR-F-52	24450509	W1.9 × H1.2	연결형	340,000	현장설치도
	BR-F-53	24450510	W1.9 × H1.2	연결형	350,000	현장설치도

디자인형울타리

대표이미지	모델명	G2B식별번호	규격	TYPE	단가	인도조건
	BR-F-54	24450511	W1.9 × H1.2	연결형	370,000	현장설치도
	BR-F-55	24657083	W1.8 × H1.175	연결형	364,000	현장설치도
	BR-F-56	24657084	W1.8 × H1.175	연결형	390,000	현장설치도
	BR-F-63	24662991	W2.0 × H1.1	연결형	390,000	현장설치도
	BR-FA-2	24458201	W2.0 × H1.1	연결형	395,000	현장설치도
	BR-F-15	24880820	W2.0 × H1.1	연결형	390,000	현장설치도
	BR-F-66	24889130	W2.0 × H1.2	연결형	385,000	현장설치도
	BR-F-67	24893809	W2.0 × H1.1	독립형	350,000	현장설치도
	BR-F-68	24893810	W2.0 × H1.1	독립형	375,000	현장설치도
	BR-F-69	24889131	W1.8 × H1.1	독립형	340,000	현장설치도
	BR-F-70	24889135	W1.8 × H1.1	독립형	360,000	현장설치도

대표이미지	모델명	G2B식별번호	규격	TYPE	단가	인도조건
	BR-FTG-1	24814858	W1.0 × H1.1	독립형	930,000	현장설치도
	BR-FTG-2	24814859	W1.1 × H1.1	연결형	1,000,000	현장설치도
	BR-FU-1	24864758	W1.2 × H0.7	독립형	230,000	현장설치도
	BR-UBL-1	24318248	Φ101.6 × 1200 × 700	매립식	215,000	현장설치도
					175,000	납품하차도
	BR-UBL-2	24318249	Φ101.6 × 1500 × 700	매립식	230,000	현장설치도
					185,000	납품하차도
	BR-BL-2	24318237	Φ150 × 800	매립식	208,000	현장설치도
					178,000	납품하차도
	BR-BL-3	24318239	Φ120 × 800	매립식	205,000	현장설치도
					175,000	납품하차도
	BR-BL-4	24318240	Φ120 × 800	매립식	205,000	현장설치도
					175,000	납품하차도
	BR-BL-5	24318245	Φ120 × 800	매립식	205,000	현장설치도
					175,000	납품하차도
	BR-BL-2M	24318238	Φ150 × 800	이동식	285,000	현장설치도
					255,000	납품하차도

볼라드

대표이미지	모델명	G2B식별번호	규격	TYPE	단가	인도조건
	BR-BL-4M	24318244	Φ120 × 800	이동식	282,000	현장설치도
					252,000	납품하차도
	BR-BL-5M	24318246	Φ120 × 800	이동식	282,000	현장설치도
					252,000	납품하차도
	BR-BL-6	24318247	Φ125 × 850	매립식	240,000	현장설치도
					210,000	납품하차도
	BR-BL-7	24895772	Φ115 × 850	매립식	233,000	현장설치도
					203,000	납품하차도
	BR-BL-7M	24895773	Φ115 × 850	이동식	270,000	현장설치도
					240,000	납품하차도
	BR-BS-7	24701654	8000 × 2000 × 2009		12,450,000	현장설치도
	BR-BS-8	24701655	5000 × 2000 × 2900		9,700,000	현장설치도
	BR-BS-9	24701656	4000 × 2000 × 2900		8,500,000	현장설치도

버스승강장 |

대표이미지	모델명	G2B식별번호	규격	TYPE	단가	인도조건
	BR-BS-10	24701657	3000 × 1400 × 2900		5,200,000	현장설치도
	BR-BS-11	24701658	3000 × 1400 × 3500		7,850,000	현장설치도
	BR-BS-12	24736033	9810 × 2000 × 2850		23,610,000	현장설치도
	BR-BS-13	24736034	5010 × 2000 × 2850		13,795,000	현장설치도
	BR-BS-14	24736035	5010 × 2000 × 2850		16,450,000	현장설치도
	BR-BS-15	24736036	5010 × 1800 × 2850		13,795,000	현장설치도
	BR-BS-16	24736037	3810 × 2000 × 2850		10,590,000	현장설치도
	BR-BS-17	24736038	2610 × 2000 × 2850		8,598,000	현장설치도

자전거보관대

대표이미지	모델명	G2B식별번호	규격	TYPE	단가	인도조건
	BR-BR-1	24665614	4000 × 2000 × 2200		3,800,000	현장설치도
	BR-BR-2	24665615	4000 × 400 × 480		600,000	현장설치도
	BR-BR-3	24665616	3200 × 1600 × 2100		4,200,000	현장설치도
	BR-BR-4	24665617	96 × 333 × 660		200,000	현장설치도





(주) 아름다운길

BEAUTIFUL ROAD CO., LTD.



(주) 아름다운길

BEAUTIFUL ROAD CO., LTD.



(주) 아름다운길

BEAUTIFUL ROAD CO., LTD.



(주) 아름다운길

BEAUTIFUL ROAD CO., LTD.